

**MAMIYA C33**  
Professional

**OWNER'S MANUAL**

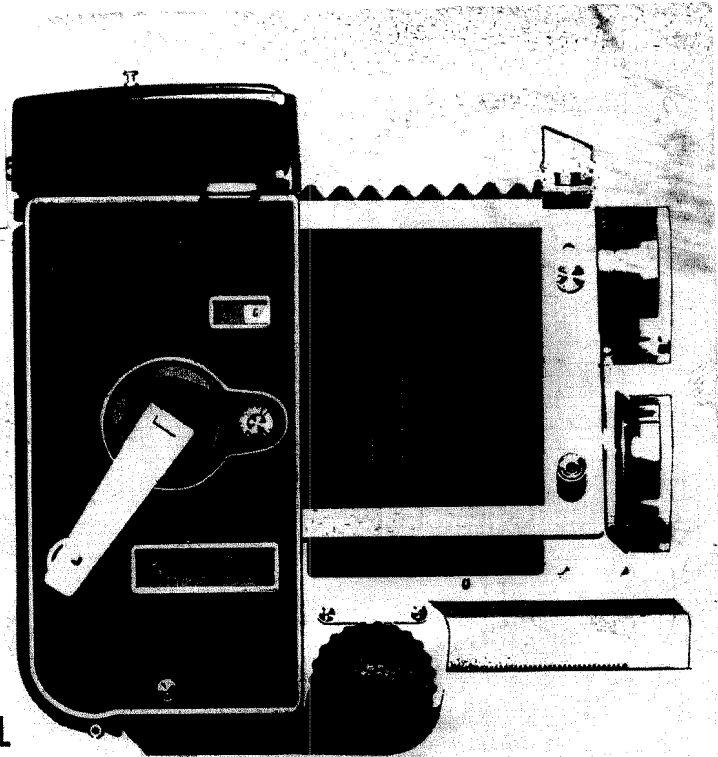

<http://stazie.dns2go.com/photographie>

## NAME OF OPERATING POINTS

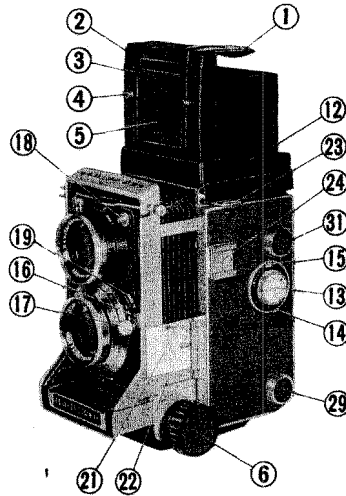
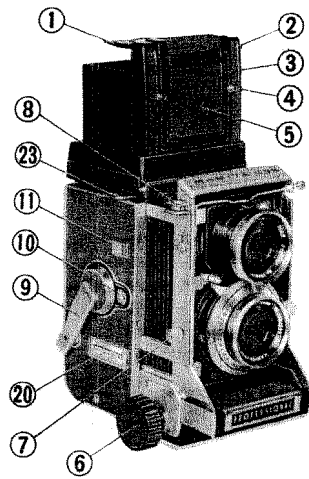

1. Magnifying Glass
2. Focusing Hood Front
3. Frame Viewfinder (for 80 mm lens)
4. Frame Viewfinder Mask Studs (right and left)
5. Frame Viewfinder Flap
6. Focusing Knobs (right and left)
7. Shutter Release Button
8. Cable Release Socket
9. Filmwind Crank
10. Multiple Exposure/ Filmstop Selector
11. Exposure Counter
12. Lens-Shutter Assembly Catch
13. Lens-Shutter Assembly Change Knob

14. Parallax Correction Lever
15. Filmspeed (ASA) Dial
16. Shutter Cocking Lever (body assembly)
17. Shutter Cocking Lever (lens-shutter assembly)
18. Synchroflash Terminal (lens-shutter assembly)
19. Synchroflash M-X Selector (lens-shutter assembly)
20. Distance Scale (right)
21. Distance Scale (left)
22. Distance Scale (left)
23. Strap Eyelets (right and left)
24. Accessory Clip
25. Focusing Hood Lock Screw
26. Backlid Catch Button
27. Red Window Cover

28. Film Chamber
29. Film Spool Catch Stud
30. Take-Up Spool Chamber
31. Take-Up Spool Catch Stud

32. Start Marks (right and left)
33. Backlid Hinge Release
34. Tripod Socket

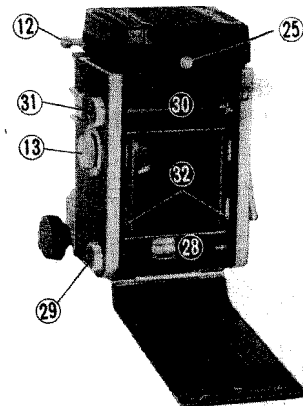
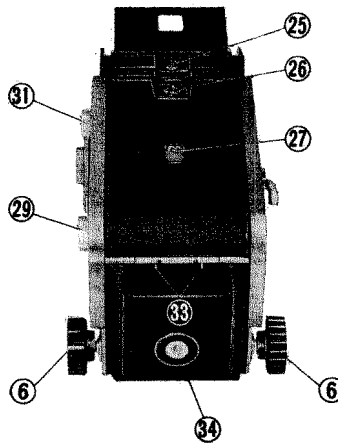

## FOCUSING HOOD OPERATION

1. The focusing hood will snap erect when the focusing hood front ② is lifted up from the rear. (Fig. 1)
2. Slight pressure on the upper section of the viewfinder flap ⑤ will release the magnifying glass ① which will spring into proper position over the ground glass viewing and focusing screen. (Fig. 2)
3. When the frame viewfinder flap ⑤ is pushed down fully it will catch and remain over the ground glass. This permits eye level viewfinding for the 80 mm lens. When frame viewfinder ③ is pushed down until it catches the direct view covers the area of the 65 mm lens. (Fig. 3)
4. To release the frame viewfinder ③ and flap ⑤ for returning to original position, first push

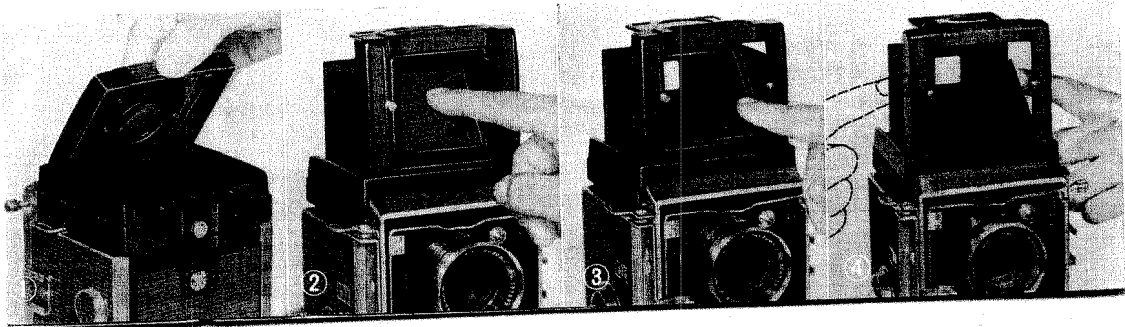

in the left side plate (as seen from the rear) of focusing hood then push in the right side plate. (Fig. 4)

5. To collapse and fold the focusing hood, first see that the frame viewfinder flap ⑤ is closed, then fold down the magnifying glass ①. Fold down the side plates and the back; hold momentarily while folding back the focusing hood front ②.

## FOCUSING

1. The method of focusing is the same as for any twin-lens reflex camera. Turn either of the focusing knobs ⑥ while keeping the image of your subject centered on the ground glass screen.
2. When using the frame viewfinder with 105 mm, 135 mm or 180 mm lenses mounted on the camera, be sure to attach proper auxiliary mask to the mask studs ④.

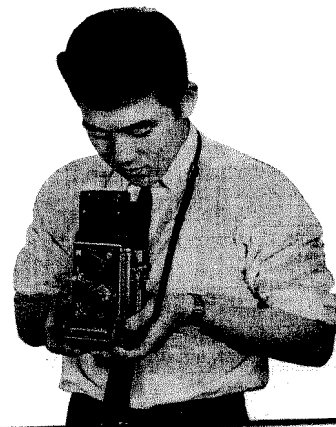

## LENS CHANGING

1. Before removing or fitting a lens-shutter assembly turn focusing knob ④ to make certain that the lens mount is fully retracted into the camera body.
2. Turn the filmwind crank counterclockwise and reset in body housing position. (Fig. 5)
3. Turn lens-shutter assembly change knob ⑬ to "UNLOCK". (Fig. 6)
4. Press down knurled head of the lens-shutter assembly catch ⑭, and allow it to swing out forward. The lens-shutter assembly can then be lifted out. (Fig. 7)
5. When exchanging the lens, press down and set the shutter cocking lever ⑰ beforehand. This procedure not only speeds up and ensures proper lens mounting, but protects the mechanism. To attach a lens-shutter assembly, lower carefully into position on the lens mount. As the cocking lever for a 180 mm lens, an auxiliary lever for coupling is provided on the side of the lens barrel. As this lever is under spring tension, press it down while



mounting the lens so that it will not interfere with mounting. (Fig. 8)

Then secure in place by replacing the lens-shutter assembly catch ⑭, turn the lens-shutter assembly change knob ⑬ to "LOCK".

★ Shutter cocking lever ⑰ cannot be meshed with the shutter cocking lever ⑰ in lens-shutter assembly unless the filmwind crank is returned to its original position.

★ A red warning signal visible under the ground glass screen indicates that the lens-shutter assembly change knob ⑬ is at "UNLOCK" position; shutter becomes inoperative and film is automatically protected from light.

6. After lens changing is completed, adjust the parallax correction lever to the index figure given on the lens mount (Fig. 9). However, when the 65 mm lens is mounted, set the lever at 80 and attach the accessory parallax correction plate to the hood.

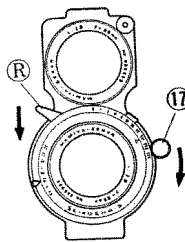
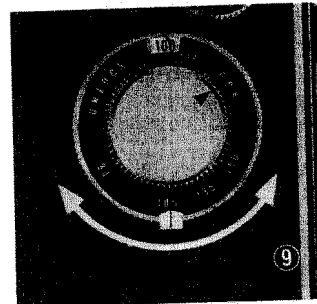

**Note:** There are two kinds of lens shutters: those with double-exposure prevention devices and those without.

To release the shutter of the lens, set the cocking lever ⑰ by pressing it down; then press down the release lever ⑲.

A shutter equipped with a double-exposure prevention device, cannot be released unless the cocking lever is set each time. In the case of a shutter without the double-exposure prevention device, the release lever can be pressed without setting the lever but the shutter vanes will not open.

## LOADING AND UNLOADING FILM

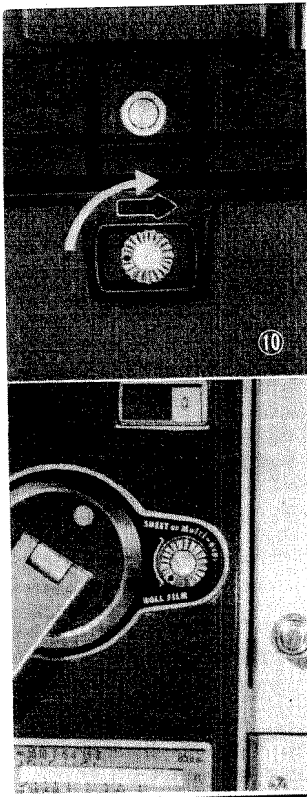

1. To open backlid, first turn backlid catch button ⑩ so that the red dot is aligned vertically, then push to the right, in the direction indicated by the arrow mark (Fig. 10). The backlid will be released, and the exposure counter ⑪ will be reset at "0".
  2. Before loading always make certain that the multiple exposure/filmstop selector ⑩ is turned to "ROLL FILM". In this position, you are assured that the shutter button ⑦ cannot be operated for release of shutter unless the film has been wound and advanced one frame. (Fig. 11)
  3. Loading and unloading film is done in the same way as with other twin-lens reflex cameras. However, on the right-hand take-up spool holder there is a yellow mark which moves when the crank is turned. This mark is provided for your convenience: align the yellow mark with the white mark on the camera body for easy loading and unloading of film. (Fig. 12)
- ★ This camera can also be used to take 24 pictures when using 220 film, by replacing the standard back with the accessory backlid. When either 120 or 220 film is used, the correct back

— 7 —

- must be attached.
4. After the film has been positioned over the film gate, and the end has been secured to the take-up spool, turn the filmwind crank ⑨, winding until the start mark (double-headed arrow) printed on the paper backing of the film comes into alignment with the start marks ⑫ near the lower side of the film gate (Fig. 13).
  5. Close backlid, and lock by turning the backlid catch button down toward the left. When closing the back, always press the right side of the catch button tightly so that both right and left sides of the back are securely engaged to the body. (Fig. 14)
  6. Turn filmwind crank ⑨ in clockwise direction until it stops. The first frame of film will be in correct position for exposure, while the exposure counter ⑪ will indicate numeral 1. Shutter will be cocked by one stroke of the filmwind crank. If it is wound up a little at a time, the shutter will not be set.
  7. After advancing the film the filmwind crank must be turned in counterclockwise direction until it stops. Shutter will not operate unless the crank is returned to its original position; never force the shutter release. (Fig. 15)

— 8 —

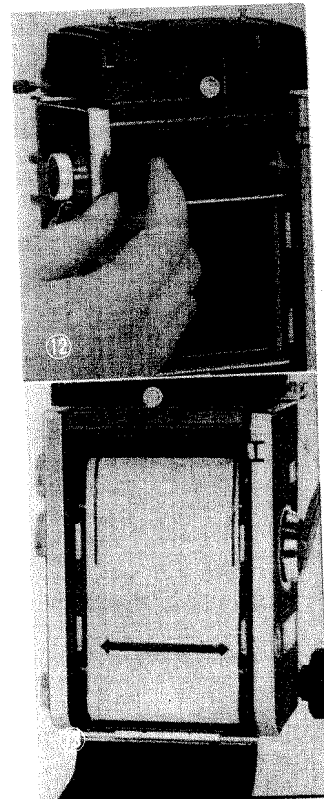

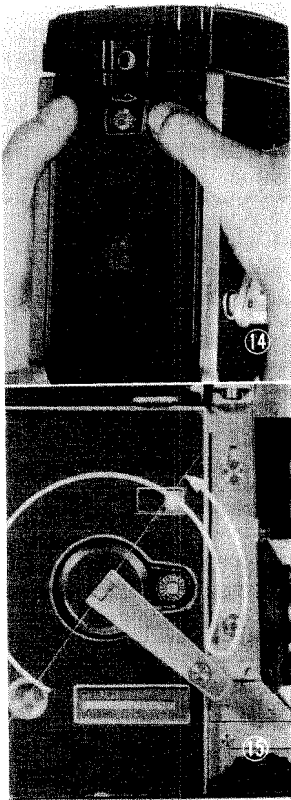

8. Repeat the above step after each operation of the shutter. When the full number of exposures have been made (12 or 24), continue advancing the film until the film is completely wound on the take-up spool. Remove film.

- ★The red window cover ⑳ is provided only on the backlid for 120 film and is used to check whether or not the camera is loaded.
- ★The exposure counter has numerals up to 24 but 13 to 24 appear only when the back for 220 film is used.
- ★When the multiple exposure/filmstop selector ⑩ is set at "ROLL FILM", the shutter button ⑦ is operable once only for each numeral, from 1 to 12 or 24, appearing in the exposure counter ⑪. This automatic locking of the shutter button for prevention of multiple exposure does not occur when camera is empty.
- ★When there is no film in the camera, crank operation will not advance exposure counter ⑪. Consequently, the shutter button cannot be operated even with the shutter cocked when the multiple exposure button ⑩ is turned to "ROLL FILM". However, if the take-up spool remains in, the same effect as film loading may result, depending on the type of spool. In such case it is not desirable to operate the crank. Avoid doing so if possible.

### **If the shutter does not operate, it does not necessarily mean trouble.**

This camera is provided with devices to prevent careless release of the shutter under the following conditions:

1. When the lens change knob is on "UNLOCK".
2. When the filmwind crank is not returned to the retracting position in the camera body.
3. When the multiple exposure button is on "ROLL FILM" and no film is loaded or the film is not advanced.

To release the shutter when the camera is not loaded with film (0 is showing at the exposure counter window) or when the film is still in the camera after the full number of pictures are taken, match the multi-exposure button to "SHEET or Multi-Exp." side. Of course, the shutter must be set each time.

### **TO TAKE MULTIPLE EXPOSURES**

First bring the red mark on the multiple exposure/filmstop selector ⑩ to "SHEET or Multi-exp." Shutter can be cocked by pushing down the shutter cocking lever ⑰ of the lens-shutter assembly. (Fig. 16) The procedures will be the same when the single-exposure attachment is employed.

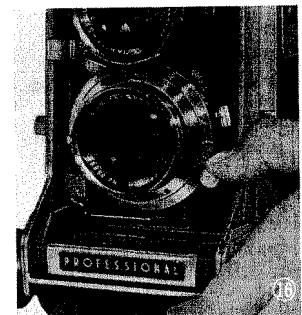

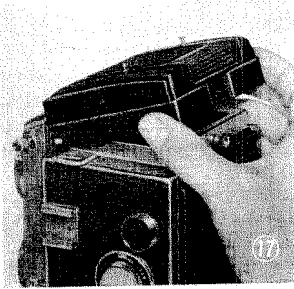

## CHANGING FOCUSING HOOD

1. The focusing hood can be easily removed by loosening the lock screw ⑳ and lifting up the rear end of the assembly.
2. To mount, match the groove on the front side of the hood to the two pins on the body; match the rear groove to the lock screw ⑳ and tighten. (Fig. 17)

## PICTURE TAKING

With this camera, an exposure index and a parallax correction scale are provided on the ground glass. The indicator needle starts to appear in the upper part of the ground glass while the focusing knob is being operated. Position of this indicator needle shows the exposure index and parallax. In this instance, the parallax correction lever ⑭ must be set at the index shown on the lens being used.

### EXPOSURE INDEX SCALE

As the distance between the lens and film becomes greater, the exposure value will be lower provided the aperture is constant. In this case, the exposure must be increased. First, take a exposure meter reading to obtain the exposure and make the correction based on the exposure index given by the camera.

— 11 —

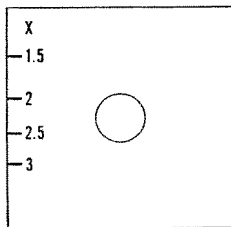

Figures given on the left side of the ground glass show exposure index. If the reading of the scale is 2 with object in focus, this indicates the necessity of doubling the exposure. For example, if the exposure meter calls for F 8 at 1/60 sec., it is necessary to adjust to 1/60 at F 5.6 or 1/30 sec. at F 8.

### PARALLAX CORRECTION SCALE

When taking pictures with the camera held in hand, the portion seen above the indicator needle on the ground glass is cut off on the film. Adjust the camera so that the subject will come under the needle.

When a tripod or stand is used, the interpositioning of the PARAMENDER (parallax compensation mount) will permit you to sight and focus without any parallax whatsoever.

### PRECAUTIONS

When the 65 mm lens is to be used, mount the accessory parallax correction plate on the hood. Remove the hood and place it with the front side to the back. The correction plate must be turned over also. Attach the plate to the hood by means of two plate catches and slide lock. In this instance, insert the edge of the plate with chamfer into the plate catches. (Fig. 18)

Figures on the left side of the correction plate show the exposure

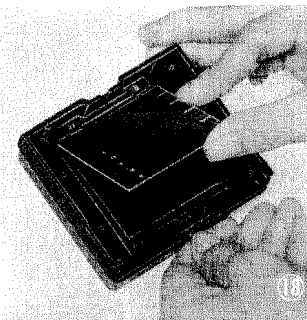

— 12 —

index; lines on the right side are for parallax. If the indicator needle points to 1.5, the section of picture above the top line will be cut off. When the scale reading is 2, the section of picture above the second line from the top will be cut off. In this way, this scale can be used for 2.5 and 3 as correction scale. Parallax correction lever ⑭, in this case, is set for 80 mm lens.

### DISTANCE SCALE AND DEPTH OF FIELD

1. When the exact distance from the camera to the subject must be determined, take a look at the distance scale. Hold the camera in shooting position; the scale ⑳ on the right side is for 80 mm and 65 mm lenses and the distance is shown on the scale by the indicator needle. On the scale ㉑ on the left side, the value is read in the intersecting points of curves representing the interchangeable lenses and the scale figures on the side of the body.

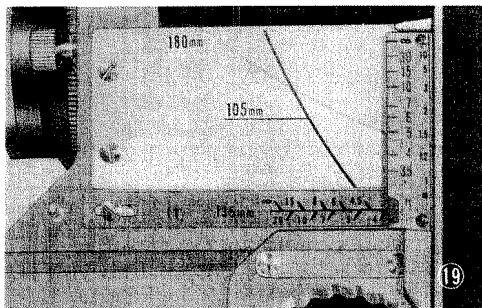

- However, the reading for 135 mm lens is separately provided under this scale and it can be directly read on the distance scale ㉒. (Fig. 19)
2. When it is necessary to check the available depth of field, obtain the distance to the subject either by referring to the distance scale or by actual measurement, then make use of the depth of field table.

— 13 —

### SINGLE EXPOSURE PHOTOGRAPHY

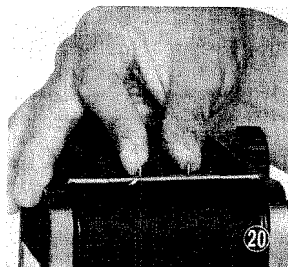

Remove backlid by pushing inward the backlid hinge release ㉓, lock pivots by turning up into the slots, and finally unlock and release backlid catch. The backlid will come off completely.

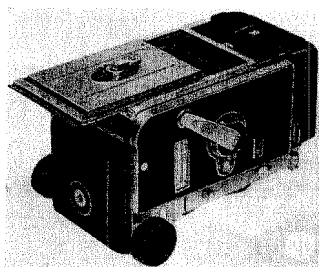

Remove the spool from inside the camera, then attach the special single-exposure back, reversing the removal procedure. Slide plate or cut film holder, loaded, into the grooves of the single-exposure back.

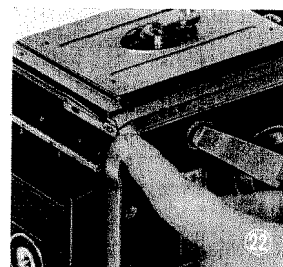

Then secure by means of the catch. You are now ready for single picture photography.

Turn multiple exposure/filmstop selector ㉔ to "SHEET or Multi-exp". At this position the shutter button can be operated at will, regardless of the filmwind crank and exposure counter.

— 14 —



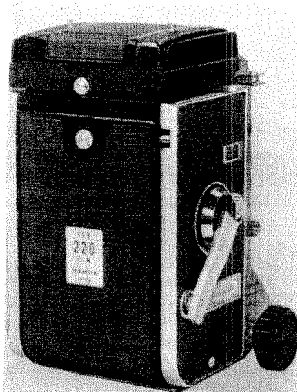

## WHEN USING 220 FILM

Remove the backlid (for 120 film) and attach the back for 220 film.

Loading and unloading of 220 film is exactly the same as for 120 film.

Twenty-four pictures are possible by using the 220 roll film back.

★When the back for 220 film is attached, the use of 120 film is not possible.

## SYNCHROFLASH PHOTOGRAPHY

1. By attaching a flashgun or electronic flash unit to the accessory clip and connecting up with the synchroflash terminal (Ⓔ), you have a handy set-up for synchroflash photography. It is convenient to make use of eye-level sighting by means of the frame finder, or the PORROFLEX.
2. Set the synchroflash M-X selector (Ⓔ) for the type of flash used. This adjustment may be done after the shutter has been cocked.
3. Position "M" gives the correct delayed shutter action for class M flashbulbs (about 20 milliseconds to peak), permitting accurate synchronization at all shutter speeds including 1/500 second.

— 15 —

4. Position "X" gives no time lag, and is used in conjunction with electronic flash (xenon strobo) for all shutter speeds, or with ordinary flashbulbs at shutter speeds not exceeding 1/30 second.
5. When not using synchroflash, keep selector (Ⓔ) at position "X".

**TABLE OF FLASH SYNCHRONIZATION**

Contact	Flash Bulb	Shutter Speed (sec.)											
		B	1	1/2	1/4	1/8	1/15	1/30	1/60	1/125	1/250	1/500	
M	M class	○	○	○	○	○	○	○	○	○	○	○	○
	Electronic Flash	○	○	○	○	○	○	○	○	○	○	○	○
X	F class	○	○	○	○	○	○	○	○	×	×	×	×
	M class	○	○	○	○	○	○	○	×	×	×	×	×

○...will synchronize      ×...will not synchronize

## INTERCHANGEABLE LENS-SHUTTER ASSEMBLIES

(MAMIYA-SEKOR lens with SEIKOSHA-S shutter)

★The lens-shutter assemblies of Mamiya C series with SEIKOSHA-MX shutter (B, 1—1/400 sec.) cannot be used for this camera.

**WIDE-ANGLE** (F 3.5, f=65 mm, 63-degree picture angle)

A 6-element, 5-group, fully corrected anastigmat with retrofocus arrangement, this lens is

— 16 —

unsurpassed for brilliance, sharpness and color fidelity. Wide-angle in conjunction with large negative size gives extreme versatility in press and candid photography. Outstandingly suitable for close range work such as copying because lens-to-subject distance can be as close as 4 inches.

When a wide angle lens is used on this camera, it is not necessary to employ a viewfinder auxiliary mask with concave lens.

**SHORT FOCAL LENGTH** (F 2.8,  $f=80\text{mm}$ ,  $50^{\circ}40'$  picture angle)

A general-purpose anastigmat of 5 elements in 3 groups, this lens permits close-range photography down to approximately 7 inches between lens and subject. It is therefore convenient for document copying and high magnification work.

**LONG FOCAL LENGTH** (F 3.5,  $f=105\text{mm}$ , 41-degree picture angle)

All-purpose 4-element, 3-group; this lens is used for portraiture and general landscapes, serving both amateur and commercial photography.

**LONG FOCAL LENGTH** (F 4.5,  $f=135\text{mm}$ , 33-degree picture angle)

Ingeniously designed 4-element, 3-group, fully corrected anastigmat, this lens gives reproductions of extreme naturalness and depth, which cannot be obtained with conventional twin-lens reflex cameras using lenses of 75 mm focal length or thereabouts. This fully corrected anastigmat is eminently suitable for portraiture, commercial art photography, and scientific

and industrial documentation.

**TELEPHOTO** (F 4.5,  $f=180\text{mm}$ ,  $24^{\circ}30'$  picture angle)

A 4-element, 3-group, fully corrected, this unique lens, because of its telephoto design and construction, does not differ much in physical length from the 135 millimeter assembly, and is particularly suitable for stage action photography, portraiture, and candid shots in situations where the subject cannot be easily approached.

The conventional 180 mm lens for the Model C cannot be mounted on this camera; use the 180 mm lens for Model C 33.

**CLOSE-RANGE PHOTOGRAPHY TABLE**

Type of Lens	Minimum Distance from Film to Subject	Subject Coverage at Minimum Distance
65mm	$10\frac{3}{16}"$	$2\frac{3}{8}" \times 2\frac{3}{8}"$
80mm	1' $1\frac{1}{2}"$	$3\frac{1}{8}" \times 3\frac{1}{8}"$
105mm	1' $10\frac{3}{16}"$	$7\frac{1}{16}" \times 7\frac{1}{16}"$
135mm	2' $8\frac{7}{16}"$	9" $\times$ 9"
180mm	3' $10\frac{1}{16}"$	$9\frac{1}{4}" \times 9\frac{1}{4}"$

## SPECIAL ACCESSORIES

**LENS HOODS** Four types are available

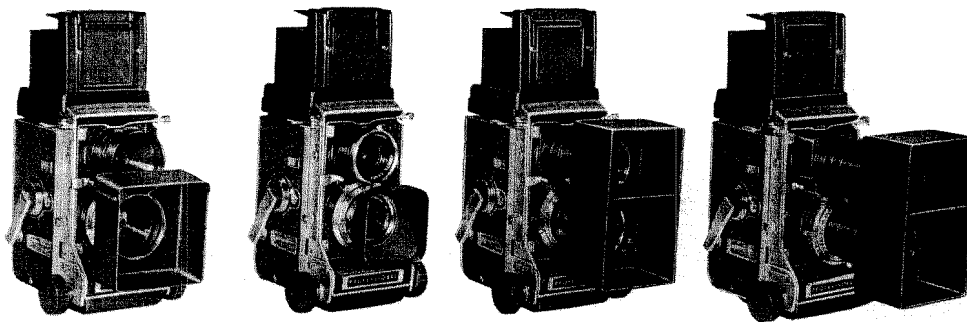

for 65 mm

for 80mm and 105 mm

for 135 mm

for 180 mm

**CAUTION:**

1. When attaching the hoods for the 135 mm and 180 mm lenses, the securing screw side should be fitted to the picture-taking (not viewfinding) lens. Otherwise the dividing partition will obstruct picture-taking.

— 19 —

2. Mount the hood for wide angle lens on the lower lens of the camera by moving side plate facing the viewing lens. During the focusing operation, reflection from the upper side plate sometimes enters the viewing lens, depending on the direction of light, affecting the image reflected on the focusing glass. When this happens, incline the upper side plate to prevent the reflection from entering the upper lens.

**FILTERS**

Filters of various types are available in three sizes:

40.5 mm diameter screw-in type for the 80 mm and 105 mm lenses

46 mm diameter screw-in type for the 135 mm lens

49 mm diameter screw-in type for the 65 mm and 180 mm lenses

Y2, YG, O2 color filters, UV ultraviolet filter, and SUNLITE filter for color film are available. When attaching filter to the 180 mm or 65 mm lens, the guard ring at front extremity of the barrel must first be removed by applying the palm and turning counterclockwise. Always replace guard ring when filter is removed. Be sure to specify filter for Model C.

**CLIP-ON DISTANCE SCALE**

When this scale is mounted on the accessory shoe, quick focusing becomes possible by setting estimated distance on the scale graduation. This is particularly convenient in flash photography or when pictures are to be made at a pre-determined distance.

— 20 —

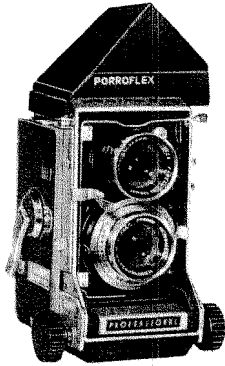

### **PORROFLEX**

This reflex mirror attachment permits eye-level viewing and focusing by means of an image in correct orientation. Fitted in the same way as the focusing hood, this viewer is indispensable for candid and press photography.

To mount, remove the hood from the camera, mount the Porroflex in its place and tighten the hood lock screw 25.

### **GRIP HOLDER**

Special grip-form handle is particularly handy for steady holding of camera during picture-taking. It also provides a mount for the flash unit.

### **SINGLE-EXPOSURE ATTACHMENT**

By using the single-exposure back in place of the standard backlid, the special plate and cut film holders permit the taking of single-frame negative pictures which are so useful in professional and advanced amateur work. Immediate

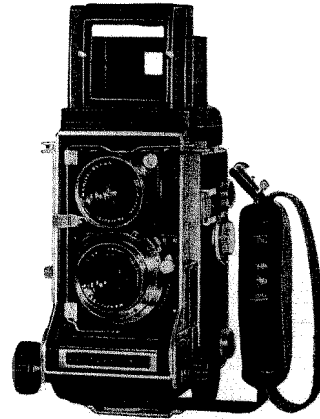

— 21 —

checking of results is possible.

### **220 ROLL FILM BACK**

By using this back, 24 pictures can be taken with 220 film.

### **PARAMENDER (Parallax Correction Mount)**

An accessory interposed between the camera and tripod or other mount, the PARAMENDER permits the lowering of the viewfinding lens down to level of picture-taking lens for parallax-free viewing during focusing and composing. Before releasing the shutter, raise the camera until it stops. The picture-taking lens comes into the position of the viewfinding lens and parallax is thus completely eliminated.

### **COMPARTMENT GADGET BAG**

A large portable case in which the camera and practically all its accessories can be stowed.

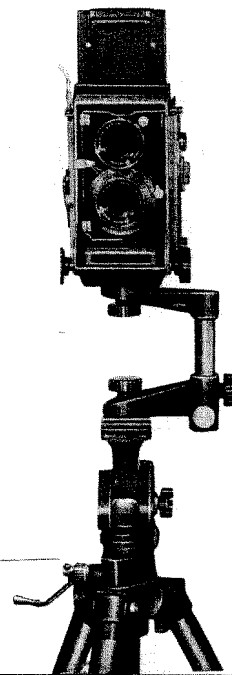

— 22 —

## WHEN USING 220 ROLL FILM

An accessory back for 220 roll film is now provided for 24 exposures by simply replacing the standard back with the accessory back.

To replace the backlid, first unlock and release the catch button, then push the hinge release inward, and lock pins by turning them up into the slots. Mount the 220 roll film back after the standard back has thus been removed.

Loading and unloading of the 220-film and method of photographing are exactly the same as when 120-film is used. However, with this camera, the start marks is located near the lower side rail of the film gate. When using either film, match the start mark of the film (double-headed arrow) to this position and then close the back.



- ★ Numerals up to 24 appear in the exposure counter window only when the back for 220-film is attached.
- ★ Since this back is only for 220-film, be sure to replace it with the standard backlid when using 120-film.

See the note on the back.

220-film can be used only in those C-22 or C-33 cameras marked with the letter "S" or "H" respectively in front of camera serial number or in cameras converted at the authorized repair shops at additional charge.



**MAMIYA CAMERA CO., LTD.**

No. 13-11, 2-CHOME, HONGO, BUNKYO-KU, TOKYO, JAPAN

30 OB 92

Printed in Japan