

Canon

SPEEDLITE
580EX II



English

Français

Español

INSTRUCTION MANUAL
MODE D'EMPLOI
MANUAL DE INSTRUCCIONES

Canon

SPEEDLITE
580EX II

English

Thank you for purchasing a Canon product.

The Canon Speedlite 580EX II is an EOS-dedicated, high-output flash unit automatically compatible with E-TTL II, E-TTL, and TTL autoflash. It can serve as an on-camera flash as well as a master unit or a slave unit in a wireless, multiple-Speedlite system. It has the same dust- and water-resistance as EOS-1D series cameras.

- **Read this instruction manual while also referring to your camera's instruction manual.**

Before using the Speedlite, read this instruction manual and your camera's instruction manual to familiarize yourself with the Speedlite operations.

- **The basic operation is as easy as with normal AE shooting.**

When the 580EX II is attached to an EOS camera, **almost all automatic exposure control for flash photography is handled by the camera.**

It is almost the same as using the camera's built-in flash if it has one. You can think of the 580EX II as a built-in, high-output flash, but attached externally.

- **It becomes automatically compatible with the camera's flash metering mode (E-TTL II, E-TTL, and TTL).**

In accordance with the camera's flash control system, the Speedlite controls the flash automatically in the respective flash metering mode:

1. E-TTL II autoflash (evaluative flash metering with preflash reading/lens distance information)
2. E-TTL autoflash (evaluative flash metering with preflash reading)
3. TTL autoflash (off-the-film metering for real-time flash metering)

Regarding the camera's available flash metering modes, refer to the "External Speedlite" specification in the "Specifications" of your camera's instruction manual.

The camera instruction manual's chapter on flash photography will refer to cameras having flash metering modes **1 or 2 as a Type-A camera** (compatible with E-TTL II or E-TTL). And cameras having flash metering mode **3 (compatible with only TTL) are called Type-B cameras.**







- * **This instruction manual assumes that you are using the Speedlite with a Type-A camera.**

For Type-B cameras, see page 55.

Contents

1	Getting Started and Basic Operation	7
2	Using Flash	13
3	Wireless Flash	33
4	Reference	47

Conventions Used in this Manual

- The <  > symbol in the text refers to the Select Dial.
- The <  > symbol in the text refers to the Select/Set button.
- The **C.Fn** symbol in the text refers to a Custom Function.
- The operation procedures in this instruction manual assume that both the camera and Speedlite's power switches are ON.
- Icons used in the text to indicate the respective buttons, dials, and settings match the same icons found on the camera and Speedlite.
- The (4) / (6) / (16) icons indicate that the respective function remains in effect for 4 sec., 6 sec., or 16 sec. after you let go of the button.
- Reference page numbers are indicated by (p.**).
- This instruction manual uses the following alert symbols:
 -  : The Caution symbol indicates a warning to prevent shooting problems.
 -  : The Note symbol gives supplemental information.

Nomenclature

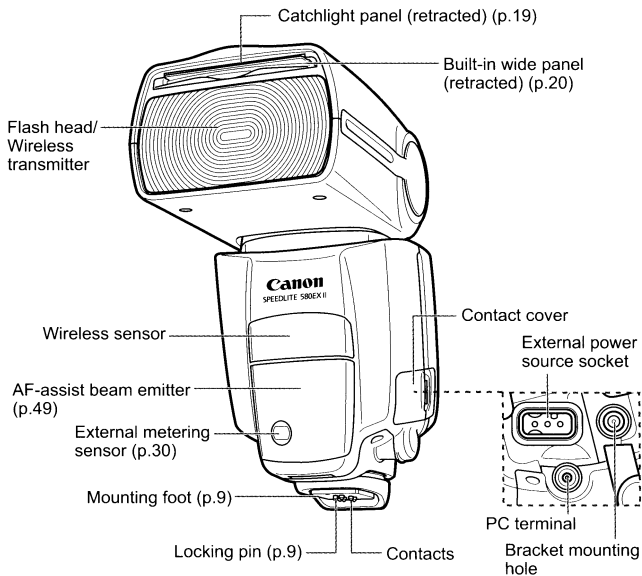

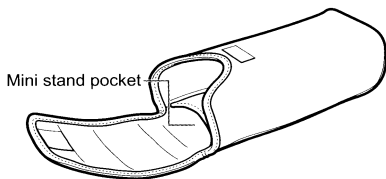

Case

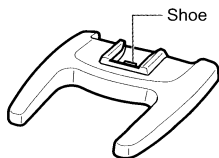

Mini stand

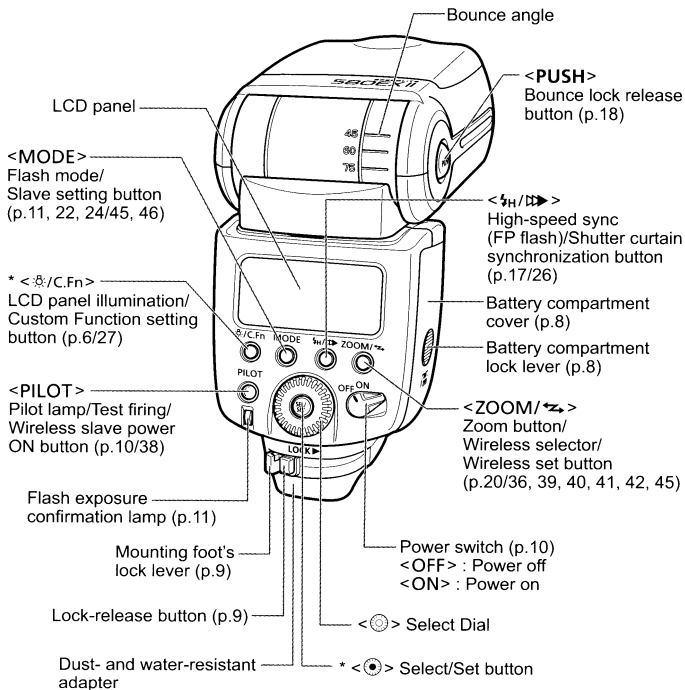



Asterisked buttons have functions which remain active for 8 sec. after you press and let go of the button. The  illumination lasts for 12 sec.

LCD Panel

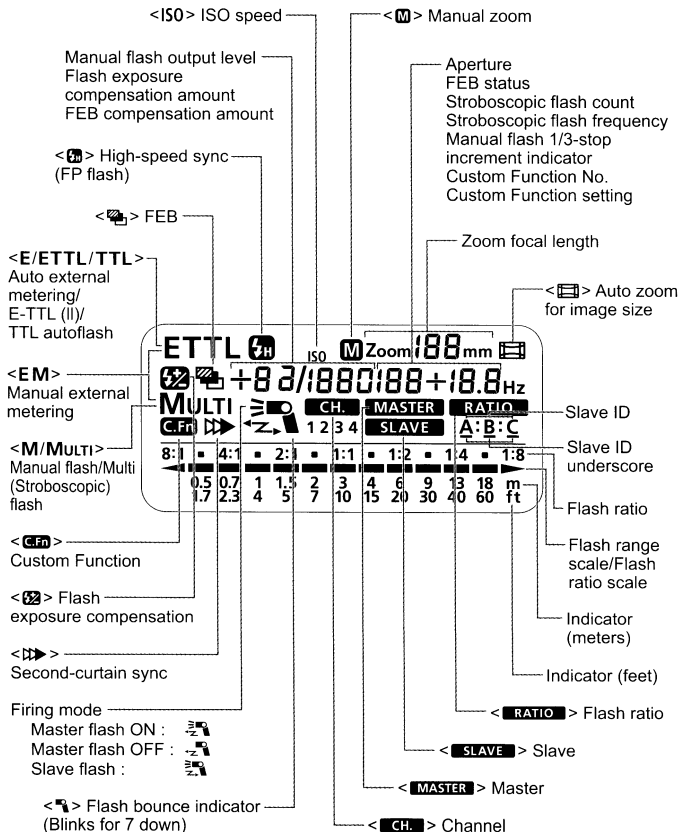

- To illuminate the LCD panel, press the **<:>** button.
- The items actually displayed depend on the current settings.



Getting Started and Basic Operation

Installing the Batteries	8
Attaching to the Camera.....	9
Turning on the Power Switch.....	10
Fully Automatic Flash Shooting.....	11
Using E-TTL II and E-TTL Autoflash in the Shooting Modes.....	12



Cautions for firing continuous flashes

- To avoid overheating and degrading the flash head, do not fire more than 20 continuous flashes. After 20 continuous flashes, allow a rest time of at least 10 min.
- If you fire more than 20 continuous flashes and then fire more flashes in short intervals, the inner overheating prevention function may be activated to make the recycling time about 8 to 20 sec. If this occurs, allow a rest time of about 15 min. and the flash will then return to normal.

Installing the Batteries

Install four size-AA batteries.

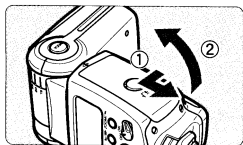

1 Open the cover.

- Use your thumb to press the battery compartment lock lever, then slide it as shown by the arrow ① to open the cover.

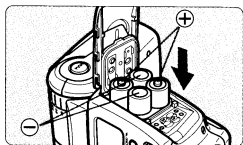

2 Install the batteries.

- Make sure the + and – battery contacts are properly oriented as shown in the compartment.

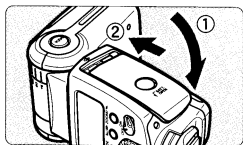

3 Close the cover.

- Close the battery compartment cover and slide it as shown by the arrow.
- ▶ When the cover clicks in place, it will be locked.

Recycling Time and Flash Count (with size-AA alkaline batteries)

Recycling Time		Flash Count
Quick Flash	Normal Flash	
Approx. 0.1 - 2.5 sec.	Approx. 0.1 - 5 sec.	Approx. 100 - 700

- Based on new size-AA alkaline batteries and Canon's testing standards.
- Quick flash enables a flash to be fired before flash-ready (p.10).

- ⚠ ● Using size-AA batteries other than the alkaline type may cause improper battery contact due to the irregular shape of the battery contacts.
- If you change the batteries after firing many flashes continuously, be aware that the batteries might be hot.

- 📄 ● Use a new set of four batteries of the same brand. When replacing the batteries, replace all four at one time.
- Size-AA Ni-MH or lithium batteries can also be used.

Attaching to the Camera

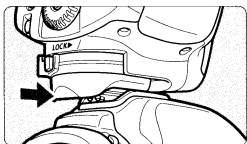

1 Attach the Speedlite.

- Slip the Speedlite's mounting foot into the camera's hot shoe all the way.

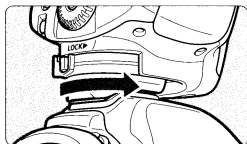

2 Secure the Speedlite.

- On the mounting foot, slide the lock lever to the right.
- ▶ When the lock lever clicks in place, it will be locked.

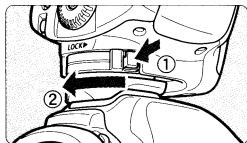

3 Detach the Speedlite.

- While pressing the lock-release button, slide the lock lever to the left and detach the Speedlite.

Turning on the Power Switch

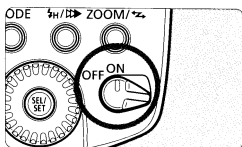

- 1 Set the power switch to <ON>.
 - ▶ The flash recycling starts.

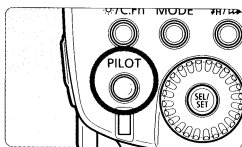

- 2 Check that the flash is ready.
 - The pilot lamp will first turn green (ready for quick flash), then red (flash ready).
 - Pressing the pilot lamp will fire a test flash.

About Quick Flash

Quick flash enables a flash to be fired before flash-ready, when the pilot lamp is still green.

Although the Guide No. will be 1/6 to 1/2 that of the full output, quick flash is effective for near subjects and when you want a shorter recycle time. Set the drive mode to single shooting. Quick flash cannot be used in the continuous shooting, FEB, manual flash, and stroboscopic flash modes.

C.Fn Quick flash can also be used during continuous flash shooting.
(C.Fn-06 → p.27)

About Auto Power Off

To save battery power, the power will turn off automatically after a certain period (approx. 1.5 min. to 15 min.) of idle use. To turn on the Speedlite again, press the camera's shutter button halfway. Or press the Speedlite's test firing button.

C.Fn Auto Power Off can also be disabled. (C.Fn-01 → p.27)



- A test flash cannot be fired while the camera's operation timer $\odot 4$ or $\odot 6$ is active.
- The Speedlite's settings will be retained in memory even after the power is turned off. To retain the Speedlite's settings after you replace the batteries, turn off the power and replace the batteries within 1 minute.

Fully Automatic Flash Shooting

When you set the camera's shooting mode to <P> (Program AE) or <□> (Full Auto), E-TTL II/E-TTL fully automatic flash will make it as easy as normal AE shooting in the <P> and <□> modes.

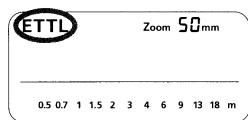

1 Set the Speedlite to <ETTL>.

- Press the <MODE> button so that <ETTL> is displayed.

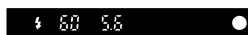

2 Focus the subject.

- Press the shutter button halfway to focus.
 - ▶ The shutter speed and aperture will be displayed in the viewfinder.
- Check that the <⚡> icon is lit in the viewfinder.

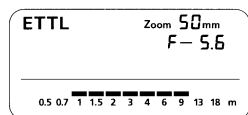

3 Take the picture.

- Check that the subject is within the effective range displayed on the LCD panel.
 - ▶ Right before the shot is taken, a preflash is fired, then the main flash is fired.
 - ▶ If a standard flash exposure was obtained, the flash exposure confirmation lamp will light for about 3 sec.

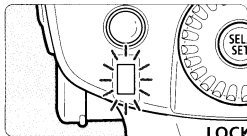

- <ETTL> will be displayed on the LCD panel even if the camera is compatible with E-TTL II.
- If the flash exposure confirmation lamp does not light, move closer to the subject and take the picture again. With a digital camera, you can also increase the camera's ISO speed.

Using E-TTL II and E-TTL Autoflash in the Shooting Modes ■

Just set the camera's shooting mode to <Av> (aperture-priority AE), <Tv> (shutter-priority AE), or <M> (manual) and you can use E-TTL II/E-TTL autofocus.

Tv	Select this mode when you want to set the shutter speed manually. The camera will then automatically set the aperture matching the shutter speed to obtain a standard exposure. <ul style="list-style-type: none">● If the aperture display blinks, it means that the background exposure will be underexposed or overexposed. Adjust the shutter speed until the aperture display stops blinking.
Av	Select this mode when you want to set the aperture manually. The camera will then automatically set the shutter speed matching the aperture to obtain a standard exposure. If the background is dark like a night scene, a slow sync speed will be used to obtain a standard exposure of both the main subject and background. Standard exposure of the main subject is obtained with the flash, while a standard exposure of the background is obtained with a slow shutter speed. <ul style="list-style-type: none">● Since a slow shutter speed will be used for low-light scenes, using a tripod is recommended.● If the shutter speed display blinks, it means that the background exposure will be underexposed or overexposed. Adjust the aperture until the shutter speed display stops blinking.
M	Select this mode if you want to set both the shutter speed and aperture manually. Standard exposure of the main subject is obtained with the flash. The exposure of the background is obtained with the shutter speed and aperture combination you set.

- If you use the <DEP> or <A-DEP> shooting mode, the result will be the same as using the <P> (Program AE) mode.





Flash Sync Speeds and Apertures Used

	Shutter Speed Setting	Aperture Setting
P	Set automatically (1/60 sec. - 1/X sec.)	Automatic
Tv	Set manually (30 sec. - 1/X sec.)	Automatic
Av	Set automatically (30 sec. - 1/X sec.)	Manual
M	Set manually (buLb, 30 sec. - 1/X sec.)	Manual

- 1/X sec. is the camera's maximum flash sync speed.

2

Using Flash



 Flash Exposure Compensation	14
 FEB	15
FEL: FE Lock	16
 High-speed Sync.....	17
Bounce Flash.....	18
ZOOM : Setting the Flash Coverage and Using the Wide Panel	20
M : Manual Flash	22
MULTI : Stroboscopic Flash	24
 Second-Curtain Sync.....	26
C.Fn: Setting Custom Functions.....	27
External Flash Metering.....	30
Speedlite Control with the Camera's Menu Screen	32

Flash Exposure Compensation

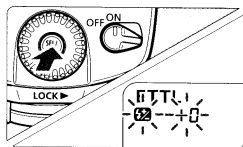
In the same way as normal exposure compensation, you can set exposure compensation for flash. The flash exposure compensation amount can be set up to ± 3 stops in 1/3-stop increments. (If the camera's exposure compensation is in 1/2-stop increments, flash exposure compensation will be in 1/2-stop increments.)



1 Select .

- Press the  button so that  is displayed.
- ▶ The  icon and the flash exposure compensation amount will blink.

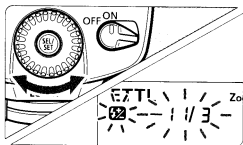

2 Set the flash exposure compensation amount.

- Turn the  dial to set the amount.
- To cancel the flash exposure compensation, set the amount to "+0."

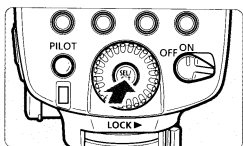

3 Press the button.

- ▶ Flash exposure compensation will be set.



If flash exposure compensation has been set with both the Speedlite and camera, the Speedlite's flash exposure compensation amount will override the camera's.





Setting the flash exposure compensation can be limited to only the  dial. (C.Fn-13 → p.27)

FEB

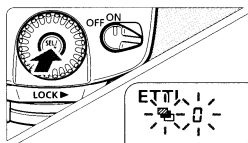
You can take three flash shots while automatically changing the flash output for each shot up to ± 3 stops in 1/3-stop increments (1/2-stop increments if the camera enables only 1/2-stop increments). This is called FEB (Flash Exposure Bracketing).



1 Select .

- Press the  button so that  is displayed.
- ▶ The  icon and bracketing amount will blink.

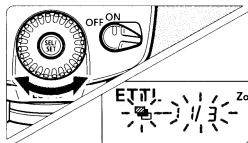

2 Set the flash exposure bracketing amount.

- Turn the  dial to set the amount.

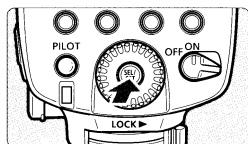

3 Press the button.

- ▶ FEB will be set.



- After the three shots are taken, FEB will be cancelled automatically.
- For FEB, set the camera's drive mode to single shooting. Be sure the flash is ready before shooting.
- You can also combine FEB with flash exposure compensation and FE lock.



You can prevent the FEB from being cancelled automatically after the three shots are taken. (C.Fn-03 → p.27)



The FEB shooting sequence can be changed. (C.Fn-04 → p.27)

FEL : FE Lock

FE (flash exposure) lock locks the correct flash exposure setting for any part of the scene.

With **<ETTL>** displayed on the LCD panel, you press the camera's **<FEL>** button. If the camera does not have the **<FEL>** button, press the **<★>** button.

1 Focus the subject.

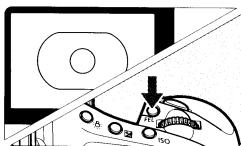

2 Press the **<FEL>** button. (☺16)

- Aim the subject at the center of the viewfinder and press the **<FEL>** button.
- ▶ The Speedlite will fire a preflash and the required flash output for the subject is retained in memory.
- ▶ **"FEL"** will be displayed in the viewfinder for 0.5 sec.
- Each time you press the **<FEL>** button, a preflash will be fired and a new flash exposure setting will be locked.



- If the subject is too far away and underexposure will result, the **<⚡>** icon will blink in the viewfinder. Move closer to the subject and try the FE lock again.
- If **<ETTL>** is not displayed on the LCD panel, FE lock cannot be set.
- If the subject is too small, FE lock might not be very effective.

High-speed Sync

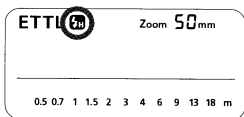

With high-speed sync (FP flash), the flash can synchronize with all shutter speeds. This is convenient when you want to use aperture priority for fill-flash portraits.



Select .

- Press the  button so that  is displayed.
- In the viewfinder, check that the  icon is displayed.



- If you set a shutter speed that is the same or slower than the camera's maximum flash sync speed,  will not be displayed in the viewfinder.
- With high-speed sync, the faster the shutter speed, the shorter the effective flash range will become. Check the LCD panel for the effective flash range.
- To return to normal flash, press the  button again. The  icon will disappear.
- Stroboscopic flash cannot be set.

Bounce Flash

By pointing the flash head toward a wall or ceiling, the flash will bounce off the surface before illuminating the subject. This can soften shadows behind the subject for a more natural-looking shot. This is called bounce flash.

Set the Bounce Direction

Hold down the <PUSH> button and turn the flash head.

If the flash coverage is set automatically, the flash coverage will be fixed to 50mm.

The LCD panel will also display <- -> mm.

- You can also set the flash coverage manually.

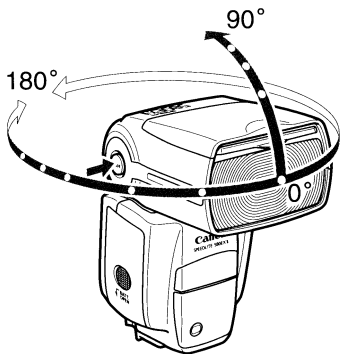

- If the wall or ceiling is too far away, the bounced flash might be too weak and result in underexposure.
- The wall or ceiling should be a plain, white color for high reflectance. If the bounce surface is not white, a color cast may result in the picture.
- After you take the shot, if the flash exposure confirmation lamp does not light, use a larger aperture opening and try again.

Creating a Catchlight

With the catchlight panel, you can create a catchlight in the subject's eyes to add life to the facial expression.

1 Point the flash head upward by 90°.

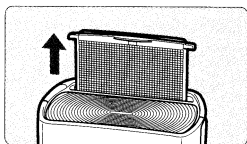

2 Pull out the wide panel.

- ▶ The catchlight panel will come out at the same time.

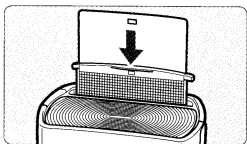

3 Push the wide panel back in.

- Push in only the wide panel.
- Follow the same procedure as for bounce flash.

- Point the flash head straight ahead and then upward by 90°. The catchlight will not work if you swing the flash head left or right.
- For maximum catchlight effect, stay within 1.5 m/4.9 ft of the subject.

Closeup Flash Shooting

When shooting a subject within about 0.5 - 2 m (1.6 - 6.6 ft) away, hold down the <PUSH> button and tilt the flash head downward by 7° to illuminate the lower part of the image.

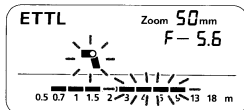

ZOOM: Setting the Flash Coverage and Using the Wide Panel

The flash coverage can be set to match the lens focal length from 24mm to 105mm. The flash coverage can be set automatically or manually. Also, with the built-in wide panel, the flash coverage can be expanded for 14mm wide-angle lenses.

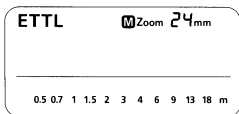

Press the <ZOOM/> button.

- Turn the <ZOOM/> dial to change the flash coverage.
- If <M> is not displayed, the flash coverage will be set automatically.



- If you set the flash coverage manually, make sure it covers the lens focal length so that the picture will not have a dark periphery.
- If you use a commercially-available sync cord to connect the camera to the Speedlite's PC terminal, set the flash zoom manually.

Using the Wide Panel

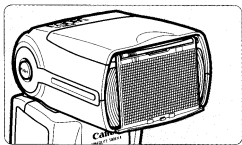

Pull out the wide panel and place it over the flash head as shown. The flash coverage will then be extended for 14mm.

- The catchlight panel will come out at the same time. Push the catchlight panel back in.
- The <ZOOM/> button will not work.



The flash coverage will not be compatible with the EF15mm f/2.8 Fisheye lens.



- If you use bounce flash with the wide panel in place, the entire display on the LCD panel will blink as a warning. Since the subject will be illuminated by both the bounce flash and direct flash, it will look unnatural.
- Pull out the wide panel gently. Using excessive force may detach the wide panel.

Auto Zoom for Image Size

EOS DIGITAL cameras have one of three image sizes. The lens' effective focal length will differ depending on the camera's image size. The Speedlite automatically recognizes the EOS DIGITAL camera's image size and automatically sets the flash coverage for lens focal lengths from 24mm to 105mm.

When the Speedlite is attached to a compatible camera,  will appear on the Speedlite's LCD panel.

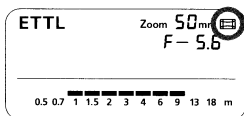

C.Fn Auto zoom can be disabled. (C.Fn-09 → p.27)

M: Manual Flash

You can set the flash output from 1/128 power to 1/1 full power in 1/3-stop increments.

Use a hand-held flash meter to determine the required flash output to obtain a correct flash exposure.

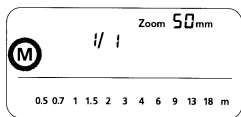

1 Press the <MODE> button so that <M> is displayed.

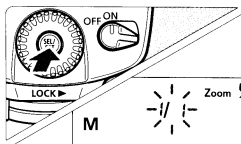

2 Set the flash output.

- Press the <◀▶> button.
- ▶ The flash output blinks.
- Turn the <◉> dial to set the flash output, then press the <◉> button.
- Press the shutter button halfway to see the effective flash range displayed.

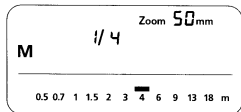

Flash Output Display

When you change the flash output during shooting, the table below makes it easier to see how the stop changes such as 1/2 -0.3 → 1/2 → 1/2 +0.3. You can see how the stop changes when you increase or decrease the flash output.

For example, when you decrease the flash output to 1/2, 1/2 -0.3, or 1/2 -0.7, and then increase the flash output to more than 1/2, 1/2 +0.3, 1/2 +0.7, and 1/1 will be displayed.

(Example) Figures for decreased flash output →

1/1	1/1 -0.3	1/1 -0.7	1/2	1/2 -0.3	1/2 -0.7	1/4	...
	1/2 +0.7	1/2 +0.3		1/4 +0.7	1/4 +0.3		...

← Figures for increased flash output

Metered Manual Flash Exposures

When the Speedlite is attached to an EOS-1D series camera, you can set the flash level manually for closeup subjects.

1 Set the camera and Speedlite.

- Set the camera's shooting mode to <M> or <Av>.
- Set the Speedlite to manual flash.

2 Focus the subject.

- Focus manually.

3 Set up an 18% gray card.

- Place the gray card at the subject's position.
- In the viewfinder, the entire spot metering circle at the center should cover the gray card.

4 Press the <FEL> button. (ⓘ16)

- ▶ The Speedlite will fire a preflash and the required flash output for the subject is retained in memory.
- ▶ On the right side of the viewfinder, the exposure level indicator will show the flash exposure level for the correct flash exposure.

5 Set the flash exposure level.

- Adjust the Speedlite's manual flash level and the camera aperture so that the flash exposure level aligns with the standard exposure index.

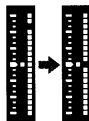

6 Take the picture.

- Remove the gray card and take the picture.



This feature works only with EX-series Speedlites with manual flash coupled with an EOS-1D series camera.

MULTI: Stroboscopic Flash

With stroboscopic flash, a rapid series of flashes is fired. It can be used to capture multiple images of a moving subject in a single photograph. You can set the firing frequency (number of flashes per sec. expressed as Hz), the number of flashes, and the flash output.

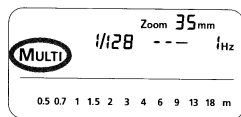

1 Press the <MODE> button so that <MULTI> is displayed.

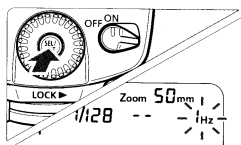

2 Select the item to be set.

- Press the <●> button to select the item (blinks).

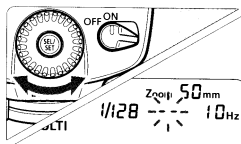

3 Set the desired number.

- Turn the <⊙> dial to set the number, then press the <●> button.
- ▶ The next item to be set will blink.
- After you set the flash output and press the <●> button, all the settings will be displayed.

Calculating the Shutter Speed

During stroboscopic flash, the shutter remains open until the firing stops. Use the formula below to calculate the shutter speed and set it with the camera.

Number of flashes ÷ Firing frequency = Shutter speed

For example, if the number of flashes is 10 and the firing frequency is 5 Hz, the shutter speed should be at least 2 sec.



To avoid overheating and deteriorating the flash head, do not use stroboscopic flash more than 10 times in succession. After 10 times, allow the Speedlite to rest for at least 15 min. If you try to use the stroboscopic flash more than 10 times in succession, the firing might stop automatically to protect the flash head. If this happens, allow the Speedlite to rest for at least 15 min.



- Stroboscopic flash is most effective with a highly reflective subject against a dark background.
- Using a tripod, a remote switch, and external power source is recommended.
- A flash output of 1/1 or 1/2 cannot be set for stroboscopic flash.
- Stroboscopic flash can be used with “**buLb.**”
- If the number of flashes is displayed as --, the firing will continue until the shutter closes or the battery is exhausted. The number of flashes will be limited as shown by the table below.

Maximum Stroboscopic Flashes

Flash Output \ Hz	1	2	3	4	5	6 - 7	8 - 9
1/4	7	6	5	4	4	3	3
1/8	14	14	12	10	8	6	5
1/16	30	30	30	20	20	20	10
1/32	60	60	60	50	50	40	30
1/64	90	90	90	80	80	70	60
1/128	100	100	100	100	100	90	80

Flash Output \ Hz	10	11	12 - 14	15 - 19	20 - 50	60 - 199
1/4	2	2	2	2	2	2
1/8	4	4	4	4	4	4
1/16	8	8	8	8	8	8
1/32	20	20	20	18	16	12
1/64	50	40	40	35	30	20
1/128	70	70	60	50	40	40

- If the number of flashes is displayed as --, the maximum number of flashes will be as shown by the table below regardless of the firing frequency.

Flash Output	1/4	1/8	1/16	1/32	1/64	1/128
Flash Count	2	4	8	12	20	40

▶▶ Second-Curtain Sync

With a slow shutter speed, you can create a light trail following the subject. The flash fires right before the shutter closes.

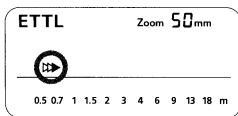

Press the <⚡/▶▶> button so that <▶▶> is displayed.





- Second-curtain sync works well in the camera's "buLb" mode.
- To return to normal flash, press the <⚡/▶▶> button again. The <▶▶> icon will disappear.
- With E-TTL II/E-TTL, two flashes will be fired even at slow shutter speeds. The first flash is only the preflash, and not a malfunction.
- Stroboscopic flash cannot be set.
- Wireless flash cannot be set.

C.Fn: Setting Custom Functions

You can customize Speedlite features to suit your shooting preferences. You do this with Custom Functions.

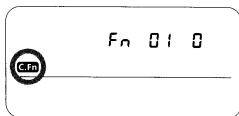
Custom Function No.	Function	Setting No.	Settings & Description	Reference page
C.Fn-00	Distance indicator display	0	Meters (m)	-
		1	Feet (ft)	-
C.Fn-01	Auto power off	0	Enabled	p.10
		1	Disabled	
C.Fn-02	Modeling flash	0	Enabled (Depth-of-field preview button)	p.44
		1	Enabled (Test firing button)	
		2	Enabled (with both buttons)	
		3	Disabled	
C.Fn-03	FEB auto cancel	0	Enabled	p.15
		1	Disabled	
C.Fn-04	FEB sequence	0	0 → - → +	
		1	- → 0 → +	
C.Fn-05	Flash metering mode	0	E-TTL II/E-TTL	p.12
		1	TTL	p.55
		2	External metering : Auto	p.30
		3	External metering : Manual	p.30
C.Fn-06	Quickflash with continuous shot	0	Disabled	p.10
		1	Enabled	
C.Fn-07	Test firing with autoflash	0	1/32	-
		1	Full output	-
C.Fn-08	AF-assist beam firing	0	Enabled	p.49
		1	Disabled	
C.Fn-09	Auto zoom for sensor size	0	Enabled	p.21
		1	Disabled	
C.Fn-10	Slave auto power off timer	0	60 minutes	p.39
		1	10 minutes	
C.Fn-11	Slave auto power off cancel	0	Within 8 hours	
		1	Within 1 hour	
C.Fn-12	Flash recycle with external power source	0	Flash and external power	p.48
		1	External power source	
C.Fn-13	Flash exposure metering setting	0	Speedlite button and dial	p.14
		1	Speedlite dial only	





- 1 Hold down the /C.Fn button until **<C.Fn>** is displayed.

2 **Select the Custom Function No.**

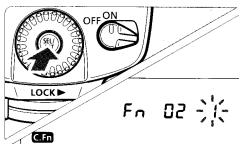
- Turn the  dial to set the Custom Function No.



3 **Change the setting.**

- Press the  button.
- ▶ The Custom Function No. blinks.
- ▶ Turn the  dial to set the desired number, then press the  button.
- ▶ After you set the Custom Function and press the **<MODE>** button, the camera will be ready to shoot.

C.Fn-02-3: Convenient when you want to check the depth of field. (p.44)

C.Fn-12: If an external power source is used, the flash recycling is powered concurrently by the internal batteries and external power source. In this case, when the internal batteries become exhausted first, shooting might not be possible. If 1 is set, the flash recycling will be powered only by the external power source. The internal batteries will thereby last longer. Note that even if you set it to 1, the Speedlite will still require internal batteries for flash control.

- C.Fn-05-1 is geared for EOS-series film cameras. Do not set it if you have a, EOS DIGITAL camera or the EOS REBEL T2/300X. If C.Fn-05-1 is set for such cameras, the flash control will not work properly. The flash might not fire or it might fire only at full output.
- With Type-A cameras, if C.Fn-05-1 is set, wireless autoflash shooting will not be possible.
- If "AF-assist beam OFF" is set with the Speedlite or camera, the AF-assist beam will not be emitted.

 With Type-B cameras, even if C.Fn-05-0 is set, E-TTL II/E-TTL autoflash will not work.

External Flash Metering

The flash reflected off the subject is metered by an external metering sensor in real time. When the standard flash exposure is attained, the flash output is cutoff automatically. Auto external metering compatible with the EOS-1D Mark III and manual external metering compatible with all EOS cameras are provided.

E: Auto External Metering

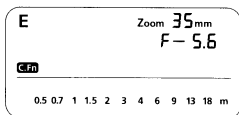

Set auto external metering.

- Set the Speedlite Custom Function to C.Fn-05-2. (p.27)



- With auto external metering, the camera's ISO speed and aperture will be set automatically in real-time by the Speedlite.
- Auto external metering will also work with flash exposure compensation (p.14) and FEB (p.15).

EM: Manual External Metering

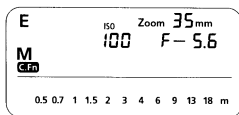

1 Set manual external metering.

- Set the Speedlite Custom Function to C.Fn-05-3. (p.27)

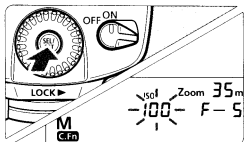

2 Set the Speedlite to the camera's ISO speed.

- Press the <ISO> button so the ISO speed blinks.
- Turn the <ISO> dial to set the ISO speed, then press the <ISO> button.

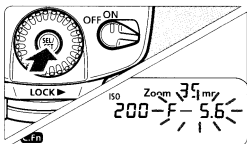

3 Set the Speedlite to the camera's aperture setting.

- Press the <⊙> button so the aperture setting blinks.
- Turn the <⊙> dial to set the aperture, then press the <⊙> button.



- After completing the settings, press the shutter button halfway. The effective flash range will be displayed on the Speedlite's LCD panel.
- With manual external metering, you can connect the camera to the Speedlite's PC terminal with a sync cord and place the Speedlite at a different position from the camera.
- You cannot connect a Speedlite to another Speedlite's PC terminal with a sync cord. The second Speedlite will not fire.



Speedlite Control with the Camera's Menu Screen ■

If the Speedlite is attached to an EOS camera which has a Speedlite control function, it can control the Speedlite as shown below. For the menu operation procedure, refer to your camera's instruction manual.

● Setting Speedlite functions

The settable functions will vary depending on the flash mode.

- Flash mode
- Shutter sync (1st/2nd curtain)
- FEB
- Flash exposure compensation
- Flash metering mode
- Flash firing
- Clear Speedlite settings

● Speedlite Custom Functions

- C.Fn-00 - 13, Total 14

● Clear All Speedlite Custom Functions

Only C.Fn-00 will not be cleared.

Flash function settings screen*

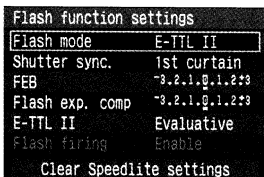

Flash C.Fn settings screen*

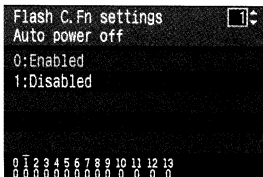

* Screens from the EOS-1D Mark III.



If flash exposure compensation has already been set with the Speedlite, flash exposure compensation cannot be set with the camera. To set it with the camera, first set the Speedlite's flash exposure compensation to zero.



If any Speedlite Custom Functions and flash function settings other than flash exposure compensation have been set by both the camera and Speedlite, the latest setting will take effect.

3

Wireless Flash

About Wireless Flash.....	34
Wireless Settings.....	36
Fully Automatic Wireless Flash	37
Flash Ratio with E-TTL II.....	41
Setting the Flash Output for Each Slave	45
Setting Manual Flash and Stroboscopic Flash with the Slave	46

About Wireless Flash

With multiple Canon Speedlites having the wireless flash feature, you can create various lighting effects with the same ease as using normal E-TTL II autoflash.

The settings you input with the 580EX II (master unit) attached to the camera are also automatically transmitted to the slave units which are controlled by the master unit via wireless. Therefore, you need not operate the slave unit(s) at all during the shoot.

The basic wireless set-up is illustrated below. All you need to do is set the master unit to <ETTL> enable wireless E-TTL II autoflash (p.37). Note that with Type-A cameras prior to the EOS-1D Mark II and EOS ELAN 7NE/ELAN 7N/30V/33V, E-TTL autoflash will be used instead.

Positioning and Operation Range

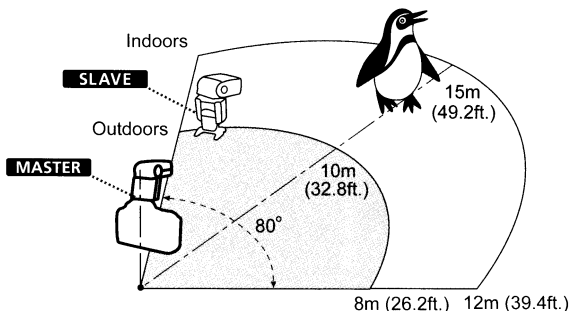

- Any flash exposure compensation, high-speed sync (FP flash), FE lock, FEB, manual flash, and stroboscopic flash settings set with the master unit will all be automatically transmitted to the slave units.
- Even with multiple slave units, all of them will be controlled in the same way via wireless.
- A 580EX II set as a slave unit can also be controlled by wireless by Speedlite Transmitter ST-E2 (optional).
- Hereinafter, the "master unit" will refer to a 580EX II attached to the camera, and a "slave unit" will be a wireless 580EX II.

Multi-Speedlite, Wireless Lighting Configurations

You can create two or three slave groups and set the flash ratio for E-TTL II autoflash shooting (p.41 - 45).

Wireless flash with two slave groups (p.41)

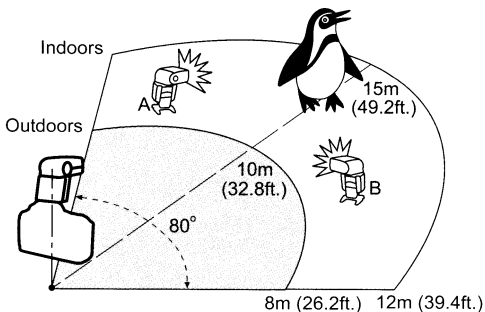

Wireless flash with three slave groups (p.43)

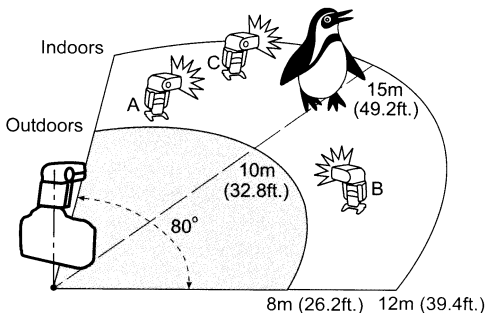

Wireless Settings

You can switch between normal flash and wireless flash. For normal shooting, be sure to set the wireless setting to OFF.

Master Unit Setting

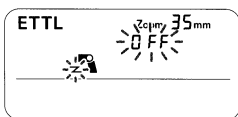

- 1 Press the <ZOOM> button for 2 sec. or longer until the display blinks as shown on the left.

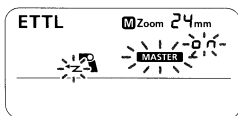

- 2 Set it as the master unit.

- Turn the <◉> dial until <MASTER> blinks, then press the <◉> button.
- ▶ <MASTER> and <CH.> will be displayed, and the Speedlite is set as the master unit.

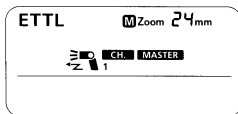

Slave Unit Setting

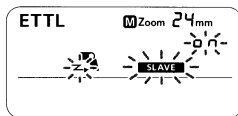

Set it as a slave unit.

- Do the "Master Unit Setting" procedure above. For step 2, turn the <◉> dial until <SLAVE> blinks, then press the <◉> button.
- ▶ <SLAVE> and <CH.> will be displayed, and the Speedlite is set as a slave unit.

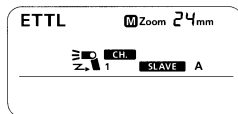

Fully Automatic Wireless Flash

This method has all the Speedlites fire at the same flash output with E-TTL II autoflash controlling the total flash output.

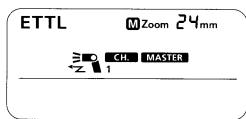

- 1 Set the camera-attached 580EX II as the master unit.

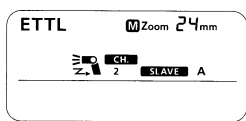

- 2 Set the other 580EX II Speedlite(s) as the wireless slave unit(s).

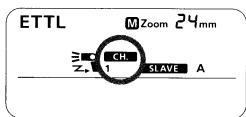

- 3 Check the communication channel.

- If the master unit and slave unit(s) are set to a different channel, set them all to the same channel (p.40).

- 4 Position the camera and Speedlites.

- Position the Speedlites within the range shown on the next page.

- 5 Set the master unit's flash mode to <ETTL>.

- For shooting, <ETTL> will also be set automatically for the slave unit(s).

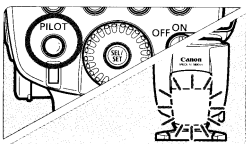

- 6 Check that the flash is ready.

- When the slave unit(s) is ready to fire, the AF-assist beam will blink at 1-sec. intervals.

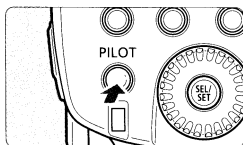

7 Check the flash operation.

- Press the master unit's test firing button.
- ▶ The slave unit will fire. If the flash does not fire, adjust the slave unit's angle toward the master unit and distance from the master unit.

8 Set the camera and shoot.

- Set the camera in the same way as with normal flash shooting.

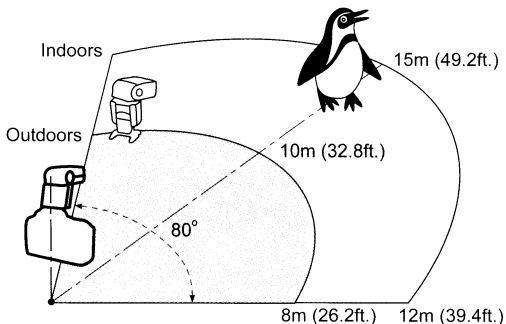

- Use the mini stand (tripod socket provided) to prop up the slave unit.
- Use the bounce feature to swing the slave unit so that its wireless sensor faces the master unit.
- Indoors, the wireless signal can also bounce off the wall so there is more leeway in positioning the slave unit(s).
- After positioning the slave unit(s), be sure to test the wireless flash operation before shooting.
- Do not place any obstacles between the master unit and slave unit(s). Obstacles can block the transmission of wireless signals.



- The Speedlite's zoom setting will be set automatically to 24mm. It is possible to change the master unit's zoom setting. However, note that the master unit transmits wireless signals to the slave unit(s) with the preflash. Therefore, the flash coverage must cover the slave unit's position. If you change the master unit's zoom setting, be sure to test the wireless flash operation before shooting.
- If the slave unit's auto power off takes effect, press the master unit's test firing button to turn on the slave unit.
- A test flash cannot be fired while the camera's operation timer $\odot 4$ or $\odot 6$ is active.

C.Fn The slave unit's auto power off time can be changed. (C.Fn-10 → p.27)

C.Fn The time during which the slave unit's auto power off can be canceled by the master unit can be changed. (C.Fn-11 → p.27)

Master Unit's Flash ON/OFF

You can disable the master unit from firing so that only the slave unit(s) will fire a flash.

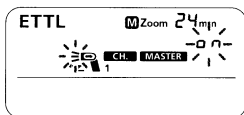

- 1 Press the <ZOOM/\leftrightarrow> button so that the display blinks as shown on the left.**

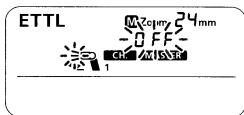

- 2 Disable the master unit's flash firing.**

- Turn the \odot dial to select $\langle \odot FF \rangle$, then press the \odot button.
- ▶ The icon will change to $\langle \rightarrow z \rightarrow \rangle$.

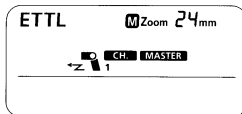

Even if you disable the master unit's flash firing, it will still fire a preflash to transmit wireless signals.

Using Fully Automatic Wireless Flash

Flash exposure compensation and other settings set with the master unit will also be automatically set in the slave units. Thus, you need not operate the slave unit(s). Wireless flash with the following settings can be done in the same way as with normal flash shooting.

- Flash exposure compensation
- FEB
- High-speed sync (FP flash)
- Manual flash
- FE lock
- Stroboscopic flash

 With FE lock, if even one Speedlite will result in underexposure, the <⚡> icon will blink in the viewfinder. Open the aperture more or move the slave unit closer to the subject.

Setting the Communication Channel

If there is another Canon wireless flash system nearby, you can change the channel No. to prevent signal confusion. Both the master and slave units must be set to the same channel No.

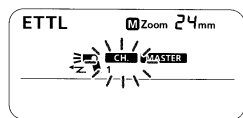

- 1 Press the <ZOOM/↔> button so that <CH.> blinks.

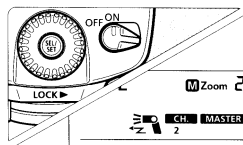

- 2 Set the channel No.
 - Turn the <DIAL> dial to select the channel number, then press the <DIAL SET> button.

Flash Ratio with E-TTL II

With one master unit and one slave unit or two slave groups, you can set the flash ratio for E-TTL II autoflash shooting.

The example below has two slave units and the master unit disabled from firing.

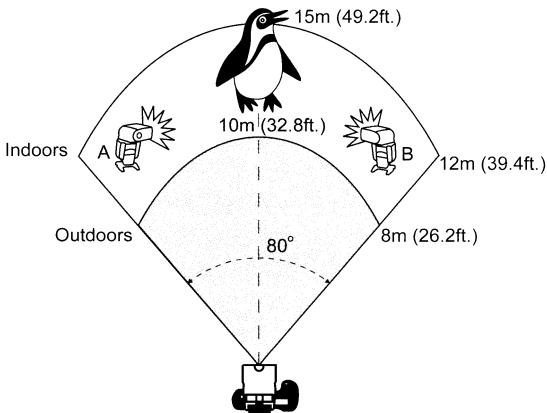



Setting the Slave Units

Two slave units can be assigned to different slave groups by setting the slave ID.

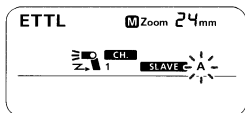
- 1 Set the wireless mode to **< SLAVE >**. (p.36)
- 2 Press the **<ZOOM/↔>** button so that **<A>** blinks.



3 Set the slave ID.

- Press the  button.
- ▶ Slave ID **<A>** will be set.
- For the other slave unit, do steps 1 and 2, turn the  dial to select ****, then press the  button.
- Slave ID **** will be set.

Setting the Master Unit and Shooting



1 Set the wireless mode to **<MASTER>**. (p.36)

2 Disable the master unit's flash firing. (p.39)

3 Press the **<ZOOM/↔>** button so that **<RATIO>** blinks.



4 Select the flash ratio.

- Turn the  dial to select **<A:B>**, then press the  button.



5 Set the flash ratio.

- Turn the  dial to set the flash ratio.

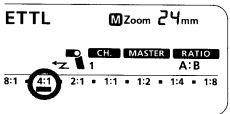

6 Set the camera and shoot.

- Set the camera in the same way as with normal flash shooting.



With the EOS ELAN II/ELAN II E/50/50E, EOS REBEL G/500N, EOS IX, EOS IX Lite/IX7, EOS REBEL 2000/300, and REBEL XS N/ REBEL G II/ EOS 3000N/66, the flash ratio cannot be set with multiple Speedlites.



- The flash ratio range of 8:1 - 1:1 - 1:8 is equivalent to 3:1 - 1:1 - 1:3 in stops (1/2-stop increments).
- The flash ratio under the ■ mark is shown in parentheses below the scale.

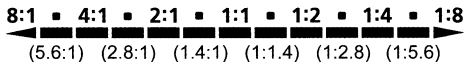

Wireless Flash with Three Slave Groups

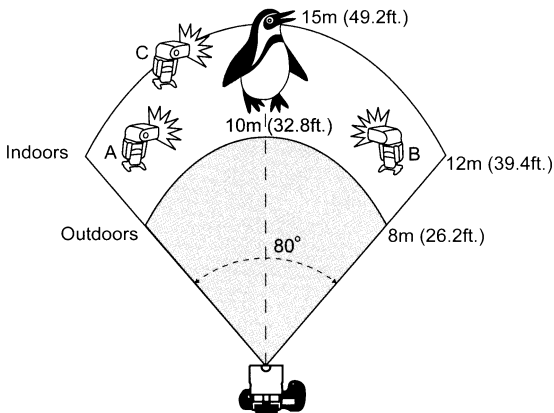

You can have slave groups A and B and also add slave group C. You can use slave groups A and B to obtain the standard flash exposure of the subject, and slave group C to illuminate the background to eliminate shadows.

1 Set the slave units.

- See "Setting the Slave Units" on page 41 to set the slave unit's ID to <A>, , or <C>.
- For slave <C>, also set the flash exposure compensation as necessary.

2 Set the master unit and shoot.

- Follow "Setting the Master Unit and Shooting" on page 42. In step 4, select <A:B C>.



- If <RATIO A:B> is set, the slave unit in slave group <C> will not fire.
- If you point the slave unit in slave group <C> toward the subject, the subject will be overexposed.

Modeling Flash

If the camera has a depth-of-field preview button, pressing it will fire the flash continuously for 1 sec. This is called the modeling flash.

It enables you to see the shadow effects on the subject and the lighting balance. You can fire the modeling flash for both wireless and normal flash shooting.



Do not fire the modeling flash more than 10 consecutive times. If you fire the modeling flash 10 consecutive times, allow the Speedlite to rest for at least 10 min. to avoid overheating and deteriorating the flash head.



The modeling flash cannot be fired with the EOS REBEL 2000/300 and Type-B cameras (p.2).

About Slave Group Control

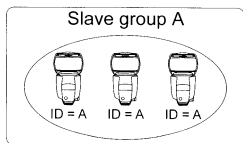

For example, if you have the slave ID set to <A> for three slave units, all three slave units will be controlled as if they were one Speedlite in slave group A.

Setting the Flash Output for Each Slave

With manual flash and multiple Speedlites, you can set a different flash output for each slave unit.

All settings are done with the master unit.

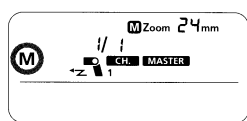

- 1 Press the <MODE> button so that <M> is displayed.

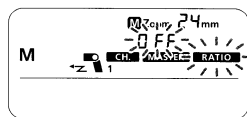

- 2 Press the <ZOOM/$\leftarrow\rightarrow$> button so that <RATIO> blinks.

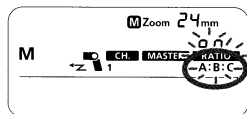

- 3 Select the flash ratio.

- Turn the <DIAL> dial to select <A:B> or <A:B:C>, then press the <DIAL> button.

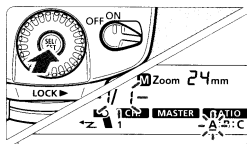

- 4 Set the flash output.

- Press the <DIAL> button.
- ▶ The slave ID <A> will blink.
- Turn the <DIAL> dial to set the flash output for <A>, then press the <DIAL> button.
- The slave ID will blink. Turn the <DIAL> dial to set the flash output for , then press the <DIAL> button.
- The slave ID <C> will blink. Turn the <DIAL> dial to set the flash output for <C>, then press the <DIAL> button.
- ▶ All the slave IDs will light.

Setting Manual Flash and Stroboscopic Flash with the Slave ■

Manual flash or stroboscopic flash can be set manually with the slave unit. As with studio flash units, you can set the flash output individually with the slave units for wireless or manual flash.

Manual Flash

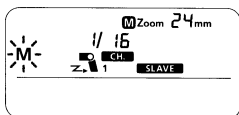

- Hold down the <MODE> button for 2 sec. or more.
- ▶ <M> will blink.
- Set the manual flash output (p.22).

Stroboscopic Flash

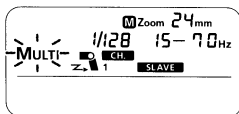

- Hold down the <MODE> button for 2 sec. or more.
- ▶ <M> will blink.
- Press the <MODE> button again and <MULTI> will blink.
- Set the stroboscopic flash (p.24).

4

Reference

580EX II System.....	48
Troubleshooting Guide	50
Specifications	52
Using a Type-B Camera	55

580EX II System

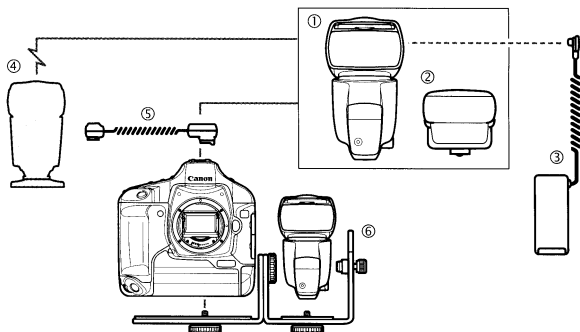

- ① **Speedlite 580EX II** (On-camera/Master unit)
- ② **Speedlite Transmitter ST-E2**
Dedicated transmitter for wireless control of 580EX II/430EX set as slave units.
- ③ **Compact Battery Pack CP-E4**
Compact, lightweight, and portable external power pack. Provides the same level of dust- and water-resistance as the 580EX II. It uses eight size-AA alkaline or Ni-MH batteries. It can also use size-AA lithium batteries.
- ④ **EX-series Speedlite with slave function**
- ⑤ **Off-Camera Shoe Cord OC-E3**
Enables the 580EX II to be connected to the camera up to 60 cm/2 ft away. Provides the same level of dust- and water-resistance as the 580EX II. All of the EOS camera's automatic functions can be used.
- ⑥ **Speedlite Bracket SB-E2**

 For the external power pack, use ③ above. If a non-Canon, external power pack is used, it may cause malfunction.

About Color Temperature Information Transmission

When the flash fires, the color temperature information is transmitted to the EOS DIGITAL camera. This feature optimizes the flash picture's white balance. When the camera's white balance is set to <AWB> or <⚡>, it will work automatically.

To see if this feature works with your camera, see "White Balance" under "Specifications" in your camera's instruction manual.

About the AF-Assist Beam

Under low-light or low-contrast conditions, the built-in AF-assist beam will be emitted automatically to make it easier to autofocus. The AF-assist beam works with all EOS cameras. The AF-assist beam is compatible with 28mm and longer lenses. The effective range is shown below.

Position	Effective Range
Center	0.6 - 10 m / 2.0 - 32.8 ft.
Periphery	0.6 - 5 m / 2.0 - 16.4 ft.

Troubleshooting Guide

If there is a problem, refer to this Troubleshooting Guide.

The Speedlite does not fire.

- **The batteries are installed in the wrong orientation.**
 - ▶ Install the batteries in the correct orientation. (p.8)
- **The Speedlite's internal batteries are exhausted.**
 - ▶ If the flash recycling time takes 30 sec. or longer, replace the batteries. (p.8)
 - ▶ Install the Speedlite's internal batteries even when you use an external power source. (p.8)
- **The Speedlite is not attached securely to the camera.**
 - ▶ Attach the Speedlite's mounting foot securely to the camera. (p.9)
- **The electrical contacts of the Speedlite and camera are dirty.**
 - ▶ Clean the contacts. (p.9)

The slave unit does not fire.

- **The slave's wireless mode is not set to < SLAVE >.**
 - ▶ Set it to < SLAVE >. (p.36)
- **The slave unit(s) is not positioned properly.**
 - ▶ Place the slave unit within the master unit's transmission range. (p.38)
 - ▶ Point the slave unit(s)'s sensor toward the master unit. (p.38)

The power turns off by itself.

- **After 90 sec. of idle operation, auto power off took effect.**
 - ▶ Press the shutter button halfway or press the test firing button. (p.10)

The entire LCD panel blinks.

- **The wide panel has been pulled out for bounce flash.**
 - ▶ Retract the wide panel. (p.20)

Auto zoom does not work.

- **The Speedlite is not attached securely to the camera.**
 - ▶ Attach the Speedlite's mounting foot securely to the camera. (p.9)

The flash range scale bars blink.

- **The flash head has been tilted down by 7°.**
 - ▶ Change the bounce position. (p.19)

The periphery or bottom of the picture looks dark.

- **When you set the flash coverage manually, the setting was a higher number than the lens focal length, resulting in a dark periphery.**
 - ▶ Set the flash coverage that is a lower number than the lens focal length or set it to auto zoom. (p.20)
- **If only the bottom of the picture looks dark, you were too close to the subject.**
 - ▶ If the subject is closer than 2 m/6.6 ft, tilt the flash head downward by 7° (bounce flash). (p.19)

The flash exposure is underexposed or overexposed.

- **There was a highly reflective object (glass window, etc.) in the picture.**
 - ▶ Use FE lock. (p.16)
- **The subject looks very dark or very bright.**
 - ▶ Set flash exposure compensation. For a dark subject, set a decreased flash exposure. And for a bright subject, set an increased flash exposure. (p.14)
- **You used high-speed sync.**
 - ▶ With high-speed sync, the effective flash range will be shorter. Make sure the subject is within the effective flash range displayed. (p.17)

The picture is really blurred.

- **The shooting mode was set to <Av>, and the scene was dark.**
 - ▶ Use a tripod or set the shooting mode to <P>. (p.12)

Specifications

• Type

Type:	On-camera, E-TTL II/E-TTL/TTL autoflash Speedlite
Compatible cameras:	Type-A EOS cameras (E-TTL II/E-TTL autoflash) Type-B EOS cameras (TTL autoflash)
Guide No.:	58/190 (at 105mm focal length, ISO 100 in meters/feet)
Flash coverage:	24 - 105mm (14mm with wide panel) <ul style="list-style-type: none">· Auto zoom (Flash coverage set automatically to match the lens focal length and image size)· Manual zoom· Swinging/tilting flash head (bounce flash)
Flash duration:	Normal flash: 1.2 ms or shorter, Quick flash: 2.3 ms or shorter
Color temperature information transmission:	Flash color temperature information transmitted to camera when flash is fired

• Exposure Control

Exposure control system:	E-TTL II/E-TTL/TTL autoflash, auto/manual external metering, manual flash
Effective flash range: (With EF50mm f/1.4 lens at ISO 100)	Normal flash: Approx. 0.5 - 30 m / 1.6 - 98.4 ft. Quick flash: 0.5 - 7.5 m / 1.6 - 24.6 ft. (min), 0.5 - 21 m / 1.6 - 68.9 ft. (max) High-speed sync: 0.5 - 15 m / 1.6 - 49.2 ft. (1/250 sec.)
Flash exposure compensation:	Manual, FEB: ± 3 stops in 1/3-stop increments (Manual and FEB can be combined)
FE lock:	With <FEL> button or <★> button
High-speed sync:	Provided
Stroboscopic flash:	Provided (1 - 199 Hz)
Flash exposure confirmation:	Pilot lamp lights

• Flash Recycling (with size-AA alkaline batteries)

Recycling time/Flash-ready indicator:	Normal flash: Approx. 0.1 - 5 sec. / Red pilot lamp lights Quick flash: Approx. 0.1 - 2.5 sec. / Green pilot lamp lights
---------------------------------------	---

• Wireless Flash

Transmission method:	Optical pulse
Channels:	4
Wireless options:	OFF, Master, and Slave
Transmission range (Approx.):	Indoors: 12 - 15 m / 39.4 - 49.2 ft., Outdoors: 8 - 10 m / 26.2 - 32.8 ft. Master unit reception angle: $\pm 40^\circ$ horizontal, $\pm 30^\circ$ vertical
Controllable slave groups:	3 (A, B, and C)
Flash ratio control:	1:8 - 1:1 - 8:1 in 1/2-stop increments
Slave-ready indicator:	AF-assist beam blinks
Modeling flash:	Fired with camera's depth-of-field preview button

• **Custom Functions:** 14 (32 settings)

• AF-Assist Beam

Linkable AF points:	1 - 45 AF points (28mm or longer focal length)
Effective range (Approx.):	At center: 0.6 - 10 m / 2.0 - 32.8 ft., Periphery: 0.6 - 5 m / 2.0 - 16.4 ft.

• Power Source

Internal power:	Four size-AA alkaline batteries * Size-AA Ni-MH and lithium batteries also usable
Battery life (Approx. flash count):	100 - 700 flashes (with size-AA alkaline batteries)
Wireless transmissions:	Approx. 1500 transmissions (With master unit firing disabled and size-AA alkaline batteries)
Power saving:	Power off after certain period of idle operation (Approx. 1.5 min. to 15 min.) (60 min. if set as slave)
External power:	Compact Battery Pack CP-E4

• Dimensions

(W x H x D):	76 x 137 x 117 mm / 3.0 x 5.4 x 4.6 in. (excluding dust- and water-resistant adapter)
--------------	--

• **Weight** (Approx.): 405 g / 14.3 oz. (Speedlite only, excluding batteries)

- All specifications above are based on Canon's testing standards.
- Product specifications and external appearance are subject to change without notice.

Guide No. (at ISO 100, in meters/feet)

Normal Flash (Full Output) and Quick Flash

Flash Coverage (mm)	14	24	28	35	50	70	80	105
Normal Flash (Full output)	15/ 49.2	28/ 91.9	30/ 98.4	36/ 118.1	42/ 137.8	50/ 164	53/ 173.9	58/ 190.3
Quick Flash	Same as 1/2 to 1/6 manual flash output							

Manual Flash

Flash Output	Flash Coverage (mm)							
	14	24	28	35	50	70	80	105
1/1	15/ 49.2	28/ 91.9	30/ 98.4	36/ 118.1	42/ 137.8	50/ 164	53/ 173.9	58/ 190.3
1/2	10.6/ 34.8	19.8/ 65	21.2/ 69.6	25.5/ 83.7	29.7/ 97.4	35.4/ 116.1	37.5/ 123	41/ 134.5
1/4	7.5/ 24.6	14/ 45.9	15/ 49.2	18/ 59.1	21/ 68.9	25/ 82	26.5/ 86.9	29/ 95.1
1/8	5.3/ 17.4	9.9/ 32.5	10.6/ 34.8	12.7/ 41.7	14.8/ 48.6	17.7/ 58.1	18.7/ 61.4	20.5/ 67.3
1/16	3.8/ 12.5	7/ 23	7.5/ 24.6	9/ 29.5	10.5/ 34.4	12.5/ 41	13.3/ 43.6	14.5/ 47.6
1/32	2.7/ 8.9	4.9/ 16.1	5.3/ 17.4	6.4/ 21	7.4/ 24.3	8.8/ 28.9	9.4/ 30.8	10.3/ 33.8
1/64	1.9/ 6.2	3.5/ 11.5	3.8/ 12.5	4.5/ 14.8	5.3/ 17.4	6.3/ 20.7	6.6/ 21.7	7.3/ 24
1/128	1.3/ 4.3	2.5/ 8.2	2.7/ 8.9	3.2/ 10.5	3.7/ 12.1	4.4/ 14.4	4.7/ 15.4	5.1/ 16.7

Using a Type-B Camera

If you use the 580EX II with a Type-B camera (TTL autoflash camera), note the available features and restrictions below.

When a Type-B camera is used with the 580EX II set to autoflash, <**TTL**> will be displayed on the Speedlite's LCD panel. (With a Type-A camera, <**ETTL**> will be displayed.)

Features Available with Type-B Cameras

- TTL autoflash
- Flash exposure compensation
- FEB
- Manual Flash
- Stroboscopic flash
- Second-curtain sync
- Manual external metering
- Wireless slave flash with manual flash
- Wireless slave flash with stroboscopic flash

Features not Available with Type-B Cameras

- E-TTL II/E-TTL autoflash
- FE lock
- High-speed sync (FP flash)
- Autoflash with wireless flash
- Flash ratio set with wireless slave units

This device complies with Part 15 of the FCC Rules. Operation is subject to the following two conditions: (1) This device may not cause harmful interference, and (2) this device must accept any interference received, including interference that may cause undesired operation.

Do not make any changes or modifications to the equipment unless otherwise specified in the instructions. If such changes or modifications should be made, you could be required to stop operation of the equipment.

This equipment has been tested and found to comply with the limits for a class B digital device, pursuant to part 15 of the FCC Rules. These limits are designed to provide reasonable protection against harmful interference in a residential installation. This equipment generates, uses and can radiate radio frequency energy and, if not installed and used in accordance with the instructions, may cause harmful interference to radio communications.

However, there is no guarantee that interference will not occur in a particular installation. If this equipment does cause harmful interference to radio or television reception, which can be determined by turning the equipment off and on, the user is encouraged to try to correct the interference by one or more of the following measures:

- Reorient or relocate the receiving antenna.
- Increase the separation between the equipment and receiver.
- Consult the dealer or an experienced radio/TV technician for help.

This Class B digital apparatus complies with Canadian ICES-003.
Cet appareil numérique de la classe B est conforme à la norme NMB-003 du Canada.

The apparatus shall not be exposed to dripping or splashing.
Batteries shall not be exposed to excessive heat such as sunshine, fire or the like.
Dry batteries shall not be subjected to charging.



This mark indicates that the product complies with Australia's EMC regulations.



European Union (and EEA) only.

This symbol indicates that this product is not to be disposed of with your household waste, according to the WEEE Directive (2002/96/EC) and your national law. This product should be handed over to a designated collection point, e.g., on an authorized one-for-one basis when you buy a new similar product or to an authorized collection site for recycling waste electrical and electronic equipment (EEE). Improper handling of this type of waste could have a possible negative impact on the environment and human health due to potentially hazardous substances that are generally associated with EEE. At the same time, your cooperation in the correct disposal of this product will contribute to the effective usage of natural resources. For more information about where you can drop off your waste equipment for recycling, please contact your local city office, waste authority, approved WEEE scheme or your household waste disposal service. For more information regarding return and recycling of WEEE products, please visit www.canon-europe.com/environment.

(EEA: Norway, Iceland and Liechtenstein)

Canon

This Instructions booklet is dated February 2007. For information on the camera's compatibility with system accessories marketed after this date, contact your nearest Canon Service Center.

Canon

CANON INC. 30-2, Shimomaruko 3-chome, Ohta-ku, Tokyo 146-8501, Japan

U.S.A. ——— **CANON U.S.A. INC.**

One Canon Plaza, Lake Success, NY 11042-1198, U.S.A.
For all inquires concerning this product, call toll free in the U.S.
1-800-OK-CANON

CANADA ——— **CANON CANADA INC. HEADQUARTERS**

6390 Dixie Road, Mississauga, Ontario L5T 1P7, Canada

CANON CANADA INC. MONTREAL BRANCH

5990, Côte-de-Liesse, Montréal Québec H4T 1V7, Canada

CANON CANADA INC. CALGARY OFFICE

2828, 16th Street, N.E. Calgary, Alberta T2E 7K7, Canada

For all inquiries concerning this product, call toll free in Canada
1-800-OK-CANON

EUROPE, ——— **CANON EUROPA N.V.**

AFRICA & Bovenkerkerweg 59-61, P.O. Box 2262, 1180 EG Amstelveen, The Netherlands

MIDDLE EAST **CANON COMMUNICATION & IMAGE FRANCE S.A.S.**

12 Rue de l'Industrie 92414 Courbevoie Cedex, France

CANON UK LTD.

Woodhatch Reigate Surrey RH2 8BF, United Kingdom

CANON DEUTSCHLAND GmbH

Europark Fichtenhain A10, 47807 Krefeld, Germany

CANON ITALIA S.p.A.

Via Milano 8 I-20097 San Donato Milanese, Milano, Italy

CANON Schweiz AG

Geschäftsbereich Wiederverkauf, Industriestrasse 12, CH-8305 Dietlikon, Switzerland

CANON GMBH

Zetschegasse 11, A-1230 Wien, Austria

CANON España, S. A.

C/Joaquin Costa, 41, 28002 Madrid, Spain

SEQUE Soc. Nac. de Equip., Lda.,

Praça da Alegria, 58, 2°, 1269-149 Lisboa, Portugal

CENTRAL & ——— **CANON LATIN AMERICA, INC.**

SOUTH AMERICA 703 Waterford Way, Ste. 400 Miami, FL 33126, U.S.A.

ASIA ——— **CANON (China) Co., Ltd.**

15F Jinbao Building No.89 Jinbao Street, Dongcheng District, Beijing 100005, China

CANON HONGKONG CO., LTD.

19/F., The Metropolis Tower, 10 Metropolis Drive, Hunghom, Kowloon, Hong Kong

CANON SINGAPORE PTE. LTD.

1 HarbourFront Avenue, #04-01 Keppel Bay Tower, Singapore 098632

CANON KOREA CONSUMER IMAGING INC.

Startower Bldg.17F,737,Yeoksam-Dong, Kangnam-Ku, Seoul, 135-984, Korea

OCEANIA ——— **CANON AUSTRALIA PTY. LTD.**

1 Thomas Holt Drive, North Ryde, N.S.W. 2113, Australia

CANON NEW ZEALAND LTD.

Akoranga Business Park, Akoranga Drive, Northcote, Auckland, New Zealand

JAPAN ——— **CANON MARKETING JAPAN INC.**

16-6, Kohnan 2-chome, Minato-ku, Tokyo 108-8011, Japan

